



# EMBEDDED IPCS

INSTRUCTIONS FOR USE | C6 P33 BOOK MOUNT

Original Manual  
Document 20176536 EN 01



# Preface

The described hard- and software are developments of the KEB Automation KG. The enclosed documents correspond to conditions valid at printing. Misprint, mistakes and technical changes reserved.

## Signal words and symbols

Certain operations can cause hazards during the installation, operation or thereafter. There are safety informations in the documentation in front of these operations. Security signs are located on the device or machine. A warning contains signal words which are explained in the following table:

<b>⚠ DANGER</b>	Dangerous situation, which will cause death or serious injury in case of non-observance of this safety instruction.
<b>⚠ WARNING</b>	Dangerous situation, which may cause death or serious injury in case of non-observance of this safety instruction.
<b>⚠ CAUTION</b>	Dangerous situation, which may cause minor injury in case of non-observance of this safety instruction.
<b>NOTICE</b>	Situation, which can cause damage to property in case of non-observance.

### RESTRICTION

Is used when certain conditions must meet the validity of statements or the result is limited to a certain validity range.



Is used when the result will be better, more economic or trouble-free by following these procedures.

## More symbols

- ▶ This arrow starts an action step.
- / - Enumerations are marked with dots or indents.
- => Cross reference to another chapter or another page.



Note to further documentation.  
[www.keb.de/service/downloads](http://www.keb.de/service/downloads)



## Laws and guidelines

KEB Automation KG confirms with the EC declaration of conformity and the CE mark on the device nameplate that it complies with the essential safety requirements.

The EC declaration of conformity can be downloaded on demand via our website. Further information is provided in chapter "Certification".

## Warranty and liability

The warranty and liability on design, material or workmanship for the acquired device is given in the general sales conditions.



Here you will find our general sales conditions.  
[www.keb.de/terms-and-conditions](http://www.keb.de/terms-and-conditions)



Further agreements or specifications require a written confirmation.

## Support

Through multiple applications not every imaginable case has been taken into account. If you require further information or if problems occur which are not treated detailed in the documentation, you can request the necessary information via the local KEB Automation KG agency.

**The use of our units in the target products is outside of our control and therefore lies exclusively in the area of responsibility of the customer.**

The information contained in the technical documentation, as well as any user-specific advice in spoken and written and through tests, are made to best of our knowledge and information about the intended use. However, they are regarded as being only informal and changes are expressly reserved, in particular due to technical changes. This also applies to any violation of industrial property rights of a third-party. Selection of our units in view of their suitability for the intended use must be done generally by the user.

**Tests can only be done within the intended end use of the product (application) by the customer. They must be repeated, even if only parts of hardware, software or the unit adjustment are modified.**

## Copyright

The customer may use the instructions for use as well as further documents or parts from it for internal purposes. Copyrights are with KEB Automation KG and remain valid in its entirety.

This KEB product or parts thereof may contain third-party software, including free and/or open source software. If applicable, the license terms of this software are contained in the instructions for use. The instructions for use are already available to you, can be downloaded free of charge from the KEB website or can be requested from the respective KEB contact person.

Other wordmarks or/and logos are trademarks (™) or registered trademarks (®) of their respective owners.

# Table of Contents

<b>Preface</b> .....	<b>3</b>
Signal words and symbols .....	3
More symbols.....	3
Laws and guidelines.....	4
Warranty and liability.....	4
Support .....	4
Copyright.....	4
<b>Table of Contents</b> .....	<b>5</b>
<b>List of Figures</b> .....	<b>9</b>
<b>List of Tables</b> .....	<b>11</b>
<b>Glossary</b> .....	<b>12</b>
<b>Standards for control &amp; automation</b> .....	<b>13</b>
<b>1 Basic Safety Instructions</b> .....	<b>15</b>
1.1 Target Group.....	15
1.2 Transport, storage and proper use.....	16
1.3 Installation.....	16
1.4 Electrical connection .....	17
1.5 Start-up and operation.....	17
1.6 Maintenance.....	17
1.8 Repair .....	18
1.7 Disposal.....	18
<b>2 System Description</b> .....	<b>19</b>
2.1 Concepts .....	19
2.2 Highlights .....	20
2.3 Supported Operating Systems.....	20
2.3.1 Isolated Power Supply .....	21
2.4 Package .....	21
2.5 Front .....	22
2.6 Rear.....	23
2.6.1 Connectors .....	24
2.6.2 C6 P33 BM - Top Connectors / LED.....	25
2.6.3 C6 P33 RVL - Top Connectors / LED .....	26
2.6.4 KEB Remote Video Link.....	27
2.6.5 LED Signaling.....	28
2.6.6 Buttons Area.....	29
2.6.7 LED / buttons.....	30
2.6.7.1 Power button .....	30
2.6.7.2 System reset button .....	30

2.6.7.3 Watchdog rest button .....	30
2.6.7.4 Factory default rest button.....	30
2.6.7.5 PWR LED .....	30
2.6.7.6 UPS LED .....	31
2.6.7.7 OT/LB LED .....	31
2.6.7.8 WD LED .....	32
2.6.7.9 LAN LED .....	32
2.6.8 Power Supply / Earth screw.....	32
2.6.9 Battery CR2032 3V .....	33
2.6.10 CFast.....	34
2.6.11 Mass Storage.....	35
2.6.12 Add-on interfaces (optional).....	35
2.6.13 Labels position .....	35

### **3 Installation and connection ..... 36**

<b>3.1 Preparation for installation.....</b>	<b>36</b>
3.1.1 Select the mounting location .....	36
<b>3.2 Checking the package contents.....</b>	<b>36</b>
<b>3.3 Checking the operating conditions .....</b>	<b>36</b>
<b>3.4 Mounting position .....</b>	<b>36</b>
<b>3.5 Damage due to overheating .....</b>	<b>36</b>
<b>3.6 Dimenstions.....</b>	<b>37</b>
3.6.1 C6 P33 BM.....	37
<b>3.7 Mounting the device.....</b>	<b>38</b>
<b>3.8 Grounding and bonding.....</b>	<b>40</b>
3.8.1 Power supply insulation.....	41
3.8.2 Wiring diagram .....	41
3.8.3 Power connection assembly.....	42
3.8.4 Power on .....	44
<b>3.9 Shutdown .....</b>	<b>45</b>

### **4 Operating Systems ..... 46**

<b>4.1 KEB Windows Images (Windows Embedded Standard 7 / Windows 10).....</b>	<b>46</b>
4.1.1 Introduction.....	46
4.1.2 User Accounts .....	46
4.1.3 Ethernet Address.....	46
4.1.4 Usage of storage memories .....	47
4.1.5 Firewall.....	48
4.1.6 eGalax Touch Driver.....	49
<b>4.2 Windows Updates.....</b>	<b>50</b>
<b>4.3 EWF implementation in the Windows Embedded Standard 7 images .....</b>	<b>50</b>
<b>4.4 KEB Write Filter Manager (KEB-WF_MGR) .....</b>	<b>51</b>
4.4.1 Introduction.....	51

4.4.2	How EWF works.....	51
4.4.3	Protectable volumes.....	52
4.4.4	KEB EWF configuration.....	52
4.4.5	Delivery state of EWF on KEB devices .....	52
4.4.6	Using KEB_WF_Mgr .....	53
4.4.7	Dependent Volumes (typically E:\) .....	55
4.4.8	Leave the KEB_WF_Mgr.....	56
<b>4.5</b>	<b>KEB UWF Manager.....</b>	<b>57</b>
4.5.1	Introduction.....	57
4.5.2	Functioning of the UWF .....	57
4.5.3	KEB UWF configuration and usage.....	57
<b>4.6</b>	<b>KEB Linux Image.....</b>	<b>59</b>
4.6.1	Introduction.....	59
4.6.2	Service user accounts .....	59
4.6.3	Change password for service user.....	60
4.6.4	Ethernet IP Address .....	61
4.6.5	Usage of storage memories .....	61
<b>4.7</b>	<b>Common (Windows and Linux).....</b>	<b>62</b>
4.7.1	Micro-UPS Handling.....	62
4.7.2	Ip-Scan.....	63
4.7.3	Serial interface .....	64
<b>5</b>	<b>Maintenance and service .....</b>	<b>65</b>
5.1	Removing the left and the right side cover.....	65
5.2	RAM installation / removal.....	65
5.3	SSD mSATA installtion / removal.....	66
5.4	Battery installtion / removal .....	67
5.5	CFast installation / removal.....	68
5.5.1	Removal .....	68
5.6	Maintaining and cleaning.....	68
5.6.1	Procedure.....	69
<b>6</b>	<b>Technical specifications .....</b>	<b>70</b>
6.1	Block Diagram .....	70
6.2	Technical data.....	71
6.2.1	C6 P33 BM basic configuration .....	71
6.2.2	C6 P33 BM RVL basic configuration .....	71
6.2.3	Options.....	71
6.2.4	Technical specifications.....	72
6.2.5	Power supply technical data.....	73
6.2.6	System power consumption .....	74
6.3	Battery technical data .....	75
6.4	Technical support and repairs .....	76

<b>7 Certification</b> .....	<b>77</b>
7.1 Mark of conformity .....	77
7.2 UL Marking.....	79



## List of Figures

Figure 1:	Isolated Power Supply .....	21
Figure 2:	Package .....	21
Figure 3:	Front detail .....	22
Figure 4:	Rear detail .....	23
Figure 5:	Connector detail .....	24
Figure 6:	Top connectors detail .....	25
Figure 7:	Top connectors detail (RVL) .....	26
Figure 8:	Remote Video Link detail .....	27
Figure 9:	Remote Video Link detail .....	27
Figure 10:	LED signaling detail .....	28
Figure 11:	Buttons area detail .....	28
Figure 12:	Buttons area detail .....	29
Figure 13:	Buttons area detail .....	29
Figure 14:	Power supply area .....	32
Figure 15:	Battery slot detail .....	33
Figure 16:	CFast slot detail .....	34
Figure 17:	Mass storage .....	35
Figure 18:	Labels position .....	35
Figure 19:	C6 P33 BM .....	37
Figure 20:	C6 P33 BM .....	37
Figure 21:	Wall mounting procedure .....	38
Figure 22:	Wall mounting procedure .....	38
Figure 23:	Wall mounting procedure .....	39
Figure 24:	Wall mounting procedure .....	39
Figure 25:	Wall mounting procedure .....	39
Figure 26:	Power supply diagramm .....	40
Figure 27:	Power supply diagramm .....	40
Figure 28:	Grounding detail .....	41
Figure 29:	Power supply connection detail .....	41
Figure 30:	Power connector assembly .....	42
Figure 31:	Power connector assembly .....	42
Figure 32:	Power connector assembly .....	42
Figure 33:	Power connector assembly .....	42
Figure 34:	Cup installation .....	43
Figure 35:	Cup installtion .....	43
Figure 36:	Cup installation .....	43
Figure 37:	Power connector assembly .....	44
Figure 38:	Screwdriver detail .....	44
Figure 39:	Power on sequence .....	45
Figure 40:	Removing the left and the right side cover .....	65
Figure 41:	RAM installation / removal .....	65
Figure 42:	RAM installation / removal .....	66
Figure 43:	RAM installation / removal .....	66

## LIST OF FIGURES

Figure 44:	SSD mSATA installatoin / removal .....	66
Figure 45:	Battery installation / removal.....	67
Figure 46:	Battery installation / removal.....	67
Figure 47:	Battery installation / removal.....	67
Figure 48:	Battery installation / removal.....	67
Figure 49:	CFast installation / removal.....	68
Figure 50:	CFast installation / removal.....	68
Figure 51:	Block diagram .....	70
Figure 52:	Battery CR2032 detail.....	75
Figure 53:	Battery performance .....	75
Figure 54:	Battery dimensions .....	75

## List of Tables

Table 1:	PWR LED.....	30
Table 2:	UPS LED.....	31
Table 3:	OT/LB LED.....	31
Table 4:	LAN LED.....	32
Table 5:	User Accounts.....	46
Table 6:	Volume protection.....	52
Table 7:	Technical data.....	72
Table 8:	Power supply technical data.....	73
Table 9:	System power consumption.....	74
Table 10:	Battery technical data.....	75

## Glossary

0V	Earth-potential-free common point	KEB product	The KEB product is subject of this manual.
1ph	1-phase mains	KEB-I/O	Small control system from the KEB-I/O system
3ph	3-phase mains	EtherCAT SPS	
AC	AC current or voltage	KEB-I/O EtherCAT System	I/O module family
Application	The application is the intended use of the KEB product.	Manufacturer	The manufacturer is KEB, unless otherwise specified (e.g. as manufacturer of machines, engines, vehicles or adhesives).
ASCL	Asynchronous sensorless closed loop	MCM	American unit for large wire cross sections
AWG	American wire gauge	MTTF	Mean service life to failure
B2B	Business-to-business	NN	Sea level
CAN	Fieldbus system	PE	Protective earth
CODESYS	Operating system of the standard control and programming environment	PELV	Protective Extra Low Voltage
CODESYS Safety-PS	Safety programming system	PFD	Term used in the safety technology (EN 61508-1...7) for the size of error probability
COM-BIVERT	KEB drive converters	PFH	Term used in the safety technology (EN 61508-1...7) for the size of error probability per hour
COMBIVIS	KEB start-up and parameterizing software	PLC	Programmable logic controller
Customer	The customer has purchased a KEB product from KEB and integrates the KEB product into his product (customer product) or resells the KEB product (dealer)	POU	Program Organization Unit
DC	DC current or voltage	RJ45	Modular connector with 8 lines
DIN	German Institut for standardization	Safety Package	Plug in for COMBIVIS studio 6 with safety functionality
EMC	Electromagnetic compatibility	Safety PLC	Safety programmable logic controller
Emergency stop	Shutdown of a drive in emergency case (not de-energized)	Safety PLCopen	Library of the certified basic level safety blocks
Emergency switching off	Switching off the voltage supply in emergency case	SELV	Safety Extra Low Voltage (<60 V)
EN	European standard	SIL	The security integrity level is a measure for quantifying the risk reduction. Term used in the safety technology (EN 61508 -1...7)
End customer	The end customer is the user of the customer product.	USB	Universal serial bus
EtherCAT	Real-time Ethernet bus system of the company Beckhoff		
Ethernet	Real-time bus system - defines protocols, plugs, types of cables		
FE	Functional earth		
FSoE	Functional Safety over Ethernet		
GND	Reference potential, ground		
Head module	Description for the bus coupler or small control in the KEB-I/O EtherCat system		
HMI	Human machine interface (touch screen)		
IEC	International standard		
IP xx	Degree of protection (xx for level)		

## Standards for control & automation

DGUV regulation 3	Electrical installations and equipment
DIN 46228-1	Wire-end ferrules; Tube without plastic sleeve
DIN 46228-4	Wire-end ferrules; Tube with plastic sleeve
DIN IEC 60364-5-54	Low-voltage electrical installations - Part 5-54: Selection and erection of electrical equipment - Earthing arrangements, protective conductors and protective bonding conductors (IEC 64/1610/CD)
DIN VDE 0100-729	Low-voltage electrical installations - Part 7-729: Requirements for special installations or locations - Operating or maintenance gangways (IEC 60364-7-729); German implementation HD 60364-7-729
EN 1037	Safety of machinery - Prevention of unexpected start-up; German version EN 1037
EN 55011	Industrial, scientific and medical equipment - Radio frequency disturbance characteristics - Limits and methods of measurement (IEC/CISPR 11); German version EN 55011
EN 55021	Interference to mobile radiocommunications in the presence of impulse noise - Methods of judging degradation and measures to improve performance (IEC/CISPR/D/230/FDIS); German version prEN 55021
EN 60204-1	Safety of machinery - electrical equipment of machines Part 1: General requirements (VDE 0113-1, IEC 44/709/CDV)
EN 60439-1	Low-voltage switchgear and controlgear assemblies - Part 1: Type-tested and partially type-tested assemblies (IEC 60439-1); German version EN 60439-1
EN 60529	Degrees of protection provided by enclosures (IP Code) (IEC 60529)
EN 60664-1	Insulation coordination for equipment within low-voltage systems Part 1: Principles, requirements and tests (IEC 60664-1)
EN 60721-3-1	Classification of environmental conditions - Part 3-1: Classification of groups of environmental parameters and their severities - Section 1: Storage (IEC 104/648/CD)
EN 60721-3-2	Classification of environmental conditions - Part 3: Classification of groups of environmental parameters and their severities - Section 2: Transportation and handling (IEC 104/670/CD)
EN 60721-3-3	Classification of environmental conditions - Part 3: Classification of groups of environmental parameters and their severities; section 3: Stationary use at weatherprotected locations; Amendment A2 (IEC 60721-3-3); German version EN 60721-3-3
EN 61000-2-1	Electromagnetic compatibility (EMC) - Part 2: Environment - Section 1: Description of the environment - Electromagnetic environment for low-frequency conducted disturbances and signalling in public power supply systems
EN 61000-2-4	Electromagnetic compatibility (EMC) - Part 2-4: Environment; Compatibility levels in industrial plants for low-frequency conducted disturbances (IEC 61000-2-4); German version EN 61000-2-4
EN 61000-4-2	Electromagnetic compatibility (EMC) - Part 4-2: Testing and measurement techniques - Electrostatic discharge immunity test (IEC 61000-4-2); German version EN 61000-4-2
EN 61000-4-3	Electromagnetic compatibility (EMC) - Part 4-3: Testing and measurement techniques - Radiated, radio-frequency, electromagnetic field immunity test (IEC 61000-4-3); German version EN 61000-4-3
EN 61000-4-4	Electromagnetic compatibility (EMC) - Part 4-4: Testing and measurement techniques - Electrical fast transient/burst immunity test (IEC 61000-4-4); German version EN 61000-4-4
EN 61000-4-5	Electromagnetic compatibility (EMC) - Part 4-5: Testing and measurement

EN61000-4-6	techniques - Surge immunity test (IEC 61000-4-5); German version EN 61000-4-5 Electromagnetic compatibility (EMC) - Part 4-6: Testing and measurement techniques - Immunity to conducted disturbances, induced by radio-frequency fields (IEC 61000-4-6); German version EN 61000-4-6
EN61000-4-34	Electromagnetic compatibility (EMC) - Part 4-34: Testing and measurement techniques - Voltage dips, short interruptions and voltage variations immunity tests for equipment with mains current more than 16 A per phase (IEC 61000-4-34); German version EN 61000-4-34
EN 61131-2	Programmable controllers - Part 2: Equipment requirements and tests (IEC 61131-2)
EN61373	Railway applications - Rolling stock equipment - Shock and vibration tests (IEC 61373)
EN61439-1	Low-voltage switchgear and controlgear assemblies - Part 1: General rules (IEC 121B/40/CDV); German version FprEN 61439-1
EN61508-1...7	Functional safety of electrical/electronic/programmable electronic safety-related systems – Part 1...7 (VDE 0803-1...7, IEC 61508-1...7)
EN61800-2	Adjustable speed electrical power drive systems - Part 2: General requirements- Rating specifications for low voltage adjustable frequency a.c. power drive systems (VDE 0160-102, IEC 61800-2)
EN61800-3	Speed-adjustable electrical drives. Part 3: EMC requirements and specific test methods (VDE 0160-103, IEC 61800-3)
EN61800-5-1	Adjustable speed electrical power drive systems - Part 5-1: Safety requirements - Electrical, thermal and energy (IEC 61800-5-1); German version EN 61800-5-1
EN61800-5-2	Adjustable speed electrical power drive systems - Part 5-2: Safety Requirements - Functional (IEC 22G/264/CD)
EN62061	Safety of machinery - functional safety of electrical, electronic and programmable electronic safety-related systems (VDE 0113-50, IEC 62061)
EN ISO 13849-1	Safety of machinery - safety-related parts of control systems - Part 1: General principles for design (ISO 13849-1); German version EN ISO 13849-1
UL61800-5-1	American version of the EN61800-5-1 with „National Deviations“

# 1 Basic Safety Instructions

The COMBICONTROL is designed and constructed in accordance with state-of-the-art technology and the recognised safety rules and regulations. However, the use of such devices may cause functional hazards for life and limb of the user or third parties, or damages to the system and other material property.

The following safety instructions have been created by the manufacturer for the area of electric drive technology. They can be supplemented by local, country- or application-specific safety instructions. This list is not exhaustive. Non-observance of the safety instructions by the customer, user or other third party leads to the loss of all resulting claims against the manufacturer.

## NOTICE



### Hazards and risks through ignorance.

- ▶ Read the instructions for use !
- ▶ Observe the safety and warning instructions !
- ▶ If anything is unclear, please contact KEB Automation KG !

## 1.1 Target Group

This manual is written for design, project planning, servicing and commissioning experts. Qualified personnel for the purpose of this instruction manual must have the following qualifications:

- Knowledge and understanding of the safety instructions.
- Knowledge of automation technology.
- Knowledge of functional safety.
- Skills for installation and assembly of electrical equipment.
- Detection of hazards and risks of the electrical drive technology.
- Understanding of the function in the used machine.
- Knowledge of the operation of the Windows operating system.
- Knowledge of *DIN IEC 60364-5-54*.
- Knowledge of *EN 60204-1*
- Knowledge of national safety regulations (e.g. *DGUV regulation 3*).

## 1.2 Transport, storage and proper use

The transport is carried out by qualified persons in accordance with the environmental conditions specified in this manual. The devices shall be protected against excessive strains.



---

**Electronic devices contain electrostatic sensitive components.**

- ▶ Avoid contact.
  - ▶ Wear ESD-protective clothing.
- 

Do not store the devices

- in the environment of aggressive and/or conductive liquids or gases.
- with direct sunlight.
- outside the specified environmental conditions.

## 1.3 Installation

**⚠ DANGER**



---

**Do not operate in an explosive environment!**

- ▶ The device is not intended for the use in potentially explosive environment.
- 

To prevent damages to the device:

- Make sure that no components are bent and/or isolation distances are changed.
- The device must not be put into operation in case of mechanical defects. Non-compliance with the applicable standards.
- Do not allow moisture or mist to penetrate the unit.
- Avoid dust permeating the device. Allow for sufficient heat dissipation if installed in a dust-proof housing.
- Note installation position and minimum distances to surrounding elements. Do not cover the ventilation openings.
- Mounting according to the specified degree of protection.
- Make sure that no small parts fall into the device during assembly and wiring (drilling chips, screws etc.). This also applies to mechanical components, which can lose small parts during operation.
- Check the reliable fit of the device connections in order to avoid contact resistances and sparking.
- The safety instructions are to be kept!



## 1.4 Electrical connection

### ATTENTION

**In order to prevent malfunctions or unpredictable conditions, observe the following instructions:**

- ▶ For any work on the device switch off the supply voltage.
- ▶ Never bridge upstream protective devices (also not for test purposes).
- ▶ Install all required covers and protective devices for operation.
- ▶ The electrical installation shall be carried out in accordance with the relevant requirements.
- ▶ Cable cross-sections and fuses must be dimensioned according to the design of the machine manufacturer. Specified minimum / maximum values may not be fallen below /exceeded.
- ▶ With existing or newly wired circuits the person installing the units or machines must ensure the EN requirements are met.
- ▶ When using components without isolated inputs/outputs, it is necessary that equipotential bonding exists between the components to be connected (e.g. by the equipotential line). Disregard can cause destruction of the components by equalizing currents.

## 1.5 Start-up and operation

When the device is installed in machines, start-up (i.e. commencement of the intended operation) is prohibited until it is determined that the machine complies with the machine directive; Account is to be taken of [EN 60204-1](#).

- During operation, all covers and doors shall be kept closed.
- Use only approved accessories for this device.
- Never touch terminals, busbars or cable ends.

## 1.6 Maintenance

The following maintenance work has to be carried out when required, but at least once per year by authorized and trained personnel. Check unit for loose screws and plugs and tighten if necessary.

- ▶ Check unit for loose screws and plugs and tighten if necessary.
- ▶ Clean the device from dirt and dust deposits. Depending on the device, pay particular attention to ventilation slots or cooling fins.
- ▶ Examine and clean extracted air filter and cooling air filter of the control cabinet.

## 1.8 Repair

In case of malfunction, unusual noises or smells inform a person in charge!

### DANGER



#### Unauthorized exchange, repair and modifications!

##### Unpredictable malfunctions!

- ▶ The function of electronic devices can be influenced by the setting and parameterization. Never replace without knowledge of the application.
- ▶ Modification or repair is permitted only by KEB Automation KG authorized personnel.
- ▶ Only use original manufacturer parts.
- ▶ Infringement will annul the liability for resulting consequences.

## 1.7 Disposal

Electronic devices of the KEB Automation KG are exclusively professional devices for further industrial processing (so-called B2B devices).

Manufacturers of B2B devices are obliged to take back and recycle devices manufactured after 14.08.2018. These devices may not be disposed at the collection centres of public sector disposal organisations.

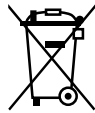

If no deviating agreement has been made between the customer and KEB or no deviating mandatory legal regulation exists, KEB products marked in this way can be returned. Company and keyword to the return point can be taken from the list below. Shipping costs are paid by the customer. Thereupon the devices will be professionally recycled and disposed.

The entry numbers are listed country-specific in the following table. The corresponding KEB return addresses can be found on our website.

Withdrawal by	WEEE-Reg.-No.	Keyword
<b>Austria</b>		
KEB Automation GmbH	ERA: 51976	Stichwort „Rücknahme WEEE“
<b>France</b>		
RÉCYLUM - Recycle point	ADEME: FR021806	Mots clés „KEB DEEE“
<b>Germany</b>		
KEB Automation KG	EAR: DE12653519	Stichwort „Rücknahme WEEE“
<b>Italy</b>		
COBAT	AEE: (IT) 19030000011216	Parola chiave „Ritiro RAEE“
<b>Spain</b>		
KEB Automation KG	RII-AEE 7427	Palabra clave „Retirada RAEE“

The packaging must be feed to paper and cardboard recycling.

## 2 System Description

C6 P33 BM is a wall book mounting IPC fanless based on sixth generation Celeron processors of the Intel® Skylake™ U platform.

C6 P33 BM systems are supplied with a sturdy aluminum chassis, highly refined in every aesthetic and ergonomic detail.

The „all in one“ motherboard provides, on top, three Ethernet 10/100/1000Mbps ports that support „Jumbo Frame“ and „Wake on Lan“ functionalities, two USB 3.0 ports, one DVI-D video output or, as an alternative, a Remote Video Link connector (RJ45) for the remotation of the video and USB signals up to 100 m; on front, a USB 3.0 port, a SATA III CFast slot, a slot for the extractable system battery and the signalling LEDs. The motherboard has also an mSATA connector for a SATA III SSD up to 16 GB RAM with one DDR4 SODIMM module and an internal connector for additional serial or USB interfaces.

C6 P33 BM systems have an isolated 24 VDC power supply input and an integrated Micro UPS with external battery pack.

### 2.1 Concepts

- On top interfaces
  - Ergonomic cabling
  - Reduced installation space
  - Protection against accidentally cable disconnection
- Front access
  - Better visibility of signals/warnings.
  - Better access to removable devices like CFast.
- Mechanic
  - Full aluminium
  - Compact, solid and robust.
  - Elegant industrial design.
  - Front interfaces protection door
- Thermic dissipation
  - Fanless operation
  - 0÷50°C operating temperature

### 2.2 Highlights

- Fanless Book Mounting IPC (0÷50°C operating temperature)
  - Compact dimensions
  - Cabling from top
  - Front access to signaling, interfaces and extractable devices
- KEB COMBIVIS connect Basic Win32/64 runtime included
- 1 x SODIMM DDR4 RAM system memory expandable up to 16GB
- On top interfaces
  - 3 x Ethernet 10/100/1000 Mbps
  - 2 x USB 3.0
  - 1 x DVI-D or 1 x Remote Video link (DVI-D and USB 2.0 up to 100 m)
  - Varied serial and USB add-on boards (optionals)
- Front access
  - Signaling LEDs and control buttons
  - 1 x CFast slot
  - 1 x system battery removable
  - 1 x USB 3.0
- Mass storage 1 x CFast, 1 x mSATA SSD interfaces
- A DVI-D video output or in alternative an integrated Remote Video Link video output for remotation of DVI-D and USB 2.0 signals up to 100 m
- Isolated 24V DC power supply input and Micro UPS

### 2.3 Supported Operating Systems

- C6 P33 BM supports the following Operating Systems:
  - Win Embedded Standard 7E/7P 32/64Bit
- Intel® Skylake platform does not support:
  - Win XP Pro 32/64bit
  - Windows Embedded Standard 2009 (XPe SP3) 32/64bit
  - Win 2000/ 98/ NT

The Intel® platform can support other operating systems but they are not certified by KEB.

### 2.3.1 Isolated Power Supply

Isolated Power supply with galvanic isolation to prevent:

- Common mode noise at low/medium frequencies on the power supply line
- Ground loop noise
- Extra-voltage caused by lightning
- Power supply with grounded positive terminal (e.g. Japan)

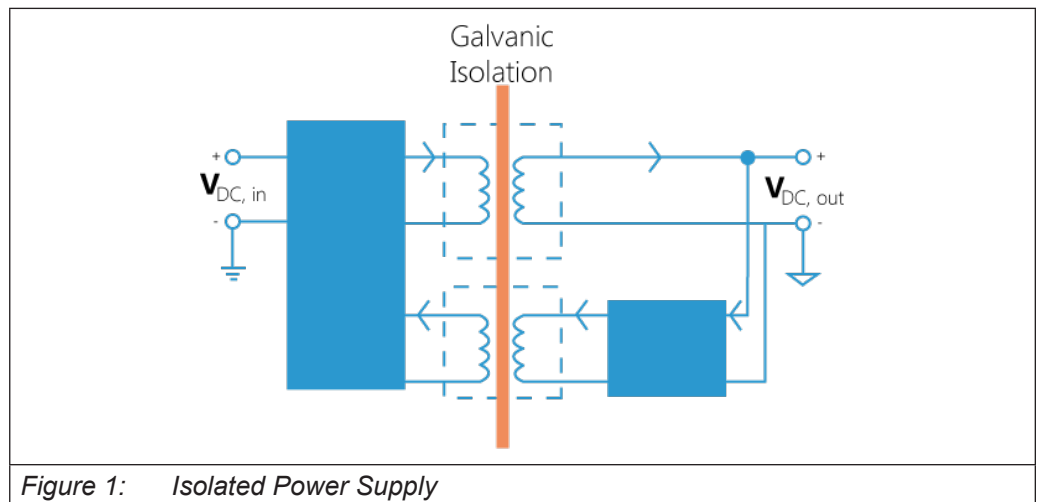

### 2.4 Package

Package consists of:

C6 E22 BM	
n.1 Power supply plug (pre-installed on the system)	
n.1 Power supply cover	
<p>Figure 2: Package</p>	

## 2.5 Front

C6 P33 BM front panel is provided with 1 door.



1	Right door
---	------------

Figure 3: Front detail

## 2.6 Rear

The back of the system is made of a full aluminium plate.

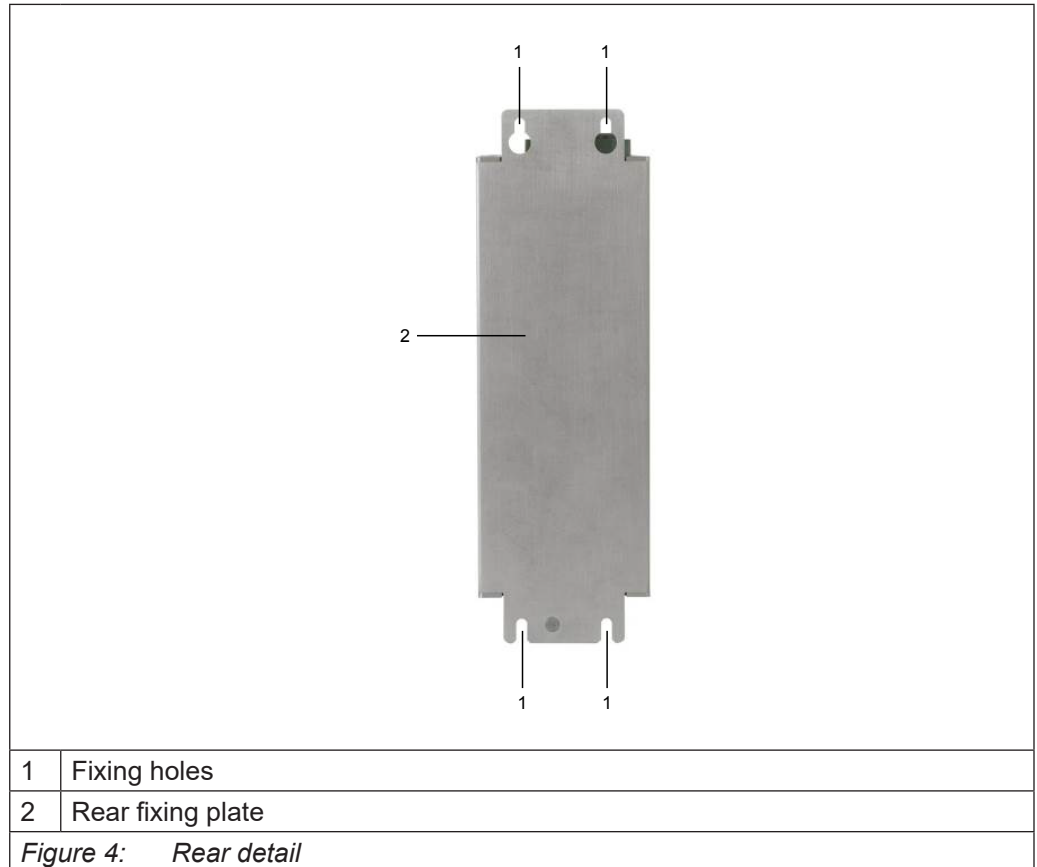

2.6.1 Connectors

To access the connectors, it is necessary to open the frontal flap.



1	Front door
2	USB 3.0 connector
3	Battery slot
4	CFAST slot sata2
5	Opening handle
<i>Figure 5: Connector detail</i>	



2.6.2 C6 P33 BM - Top Connectors / LED

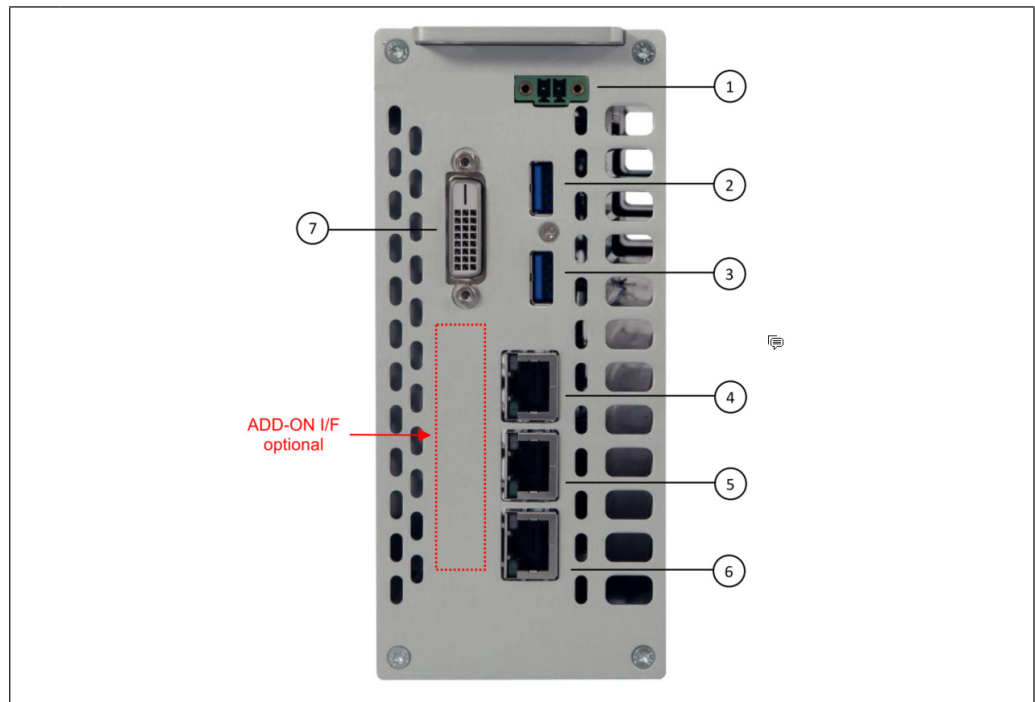

1	Power DC input connector
2	USB1 (3.0) connector
3	USB2 (3.0) connector
4	LAN1 connector
5	LAN2 connector
6	LAN2 connector
7	DVI-D connector
<i>Figure 6: Top connectors detail</i>	

2.6.3 C6 P33 RVL - Top Connectors / LED

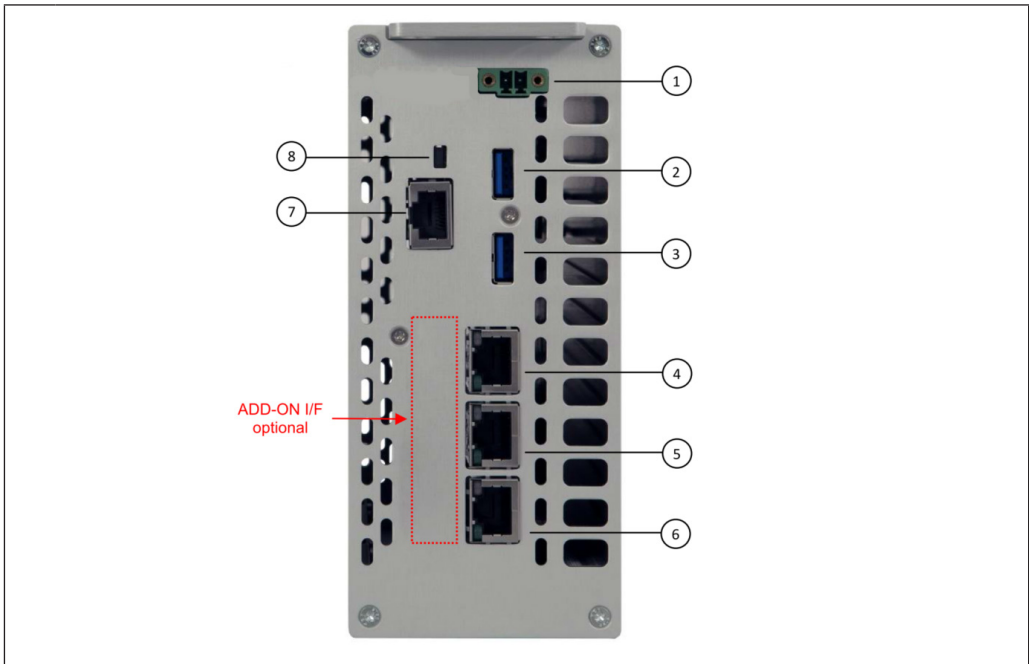

1	Power DC input connector
2	USB1 (3.0) connector
3	USB2 (3.0) connector
4	LAN 1 connector
5	LAN 2 connector
6	LAN 3 connector
7	RVL OUT
8	RVL LINK LED
<i>Figure 7: Top connectors detail (RVL)</i>	

2.6.4 KEB Remote Video Link

C6 E22 BM RVL integrates all the circuitry that allows the DVI-D and USB 2.0 signals to be reliably transmitted to a monitor up to 100 m away using a Cat 5e SF/UTP or Cat 6A SFTP (Shield Foil Twisted pair) cable.

The remotation system is composed by C6 E22 BM RVL and a KEB industrial monitor C6 Monitor or C6 AMM that integrates the RVL receiver section.

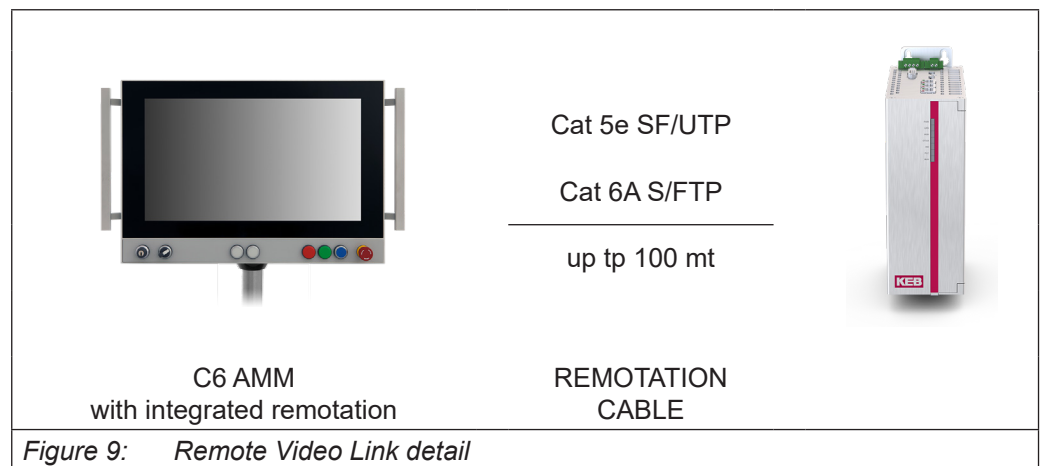
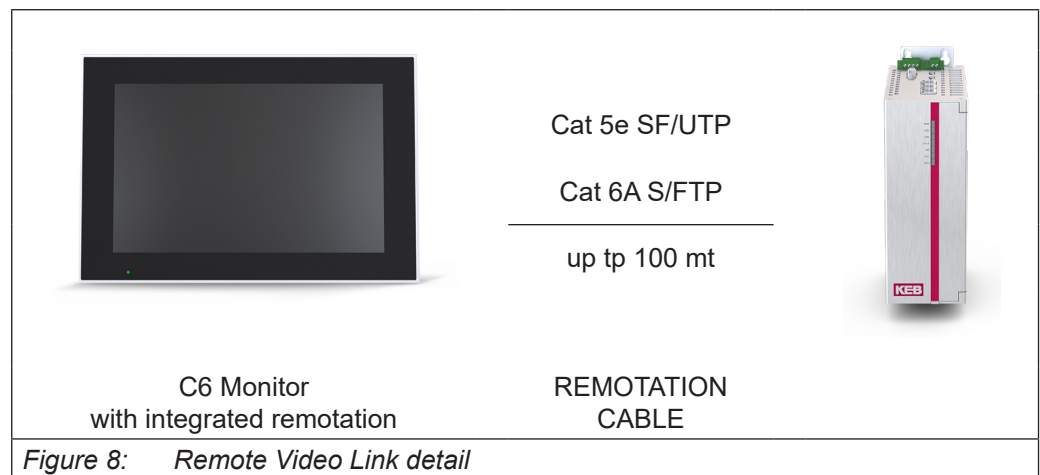

2.6.5 LED Signaling



1	LED signaling area
---	--------------------

Figure 10: LED signaling detail

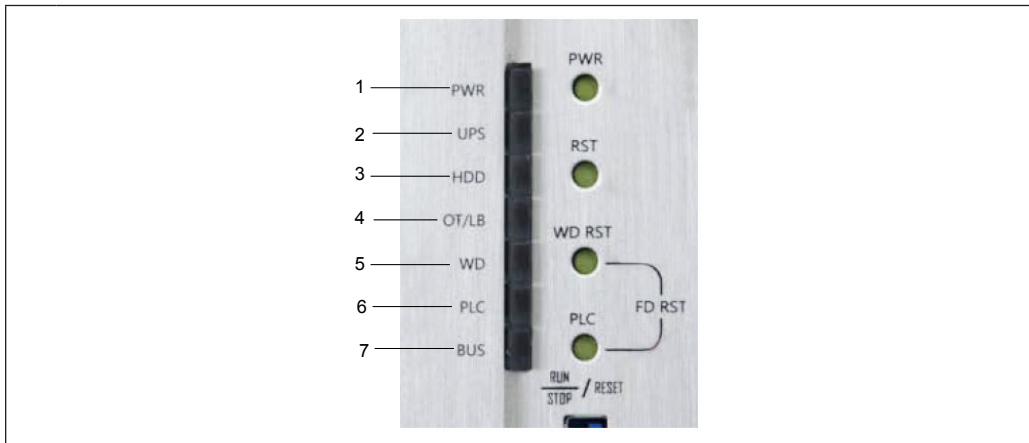

1	Power on LED
2	UPS LED
3	HDD activity LED
4	Over temperature / Battery fault LED
5	Watchdog / Reset factory default LED
6	Not available
7	Not available

Figure 11: Buttons area detail

2.6.6 Buttons Area



1	Buttons area
---	--------------

Figure 12: Buttons area detail

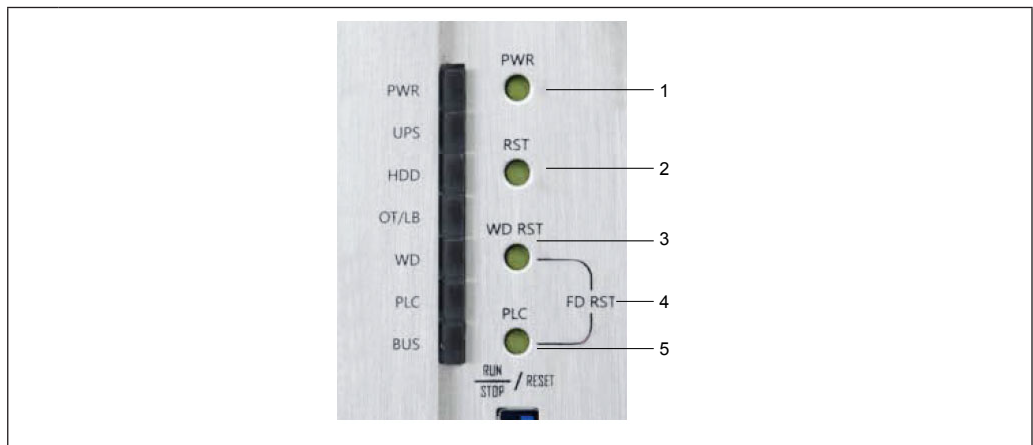

1	Power button
---	--------------

2	System reset
---	--------------

3	Watchdog reset
---	----------------

4	Factory default reset
---	-----------------------

5	Not available
---	---------------

Figure 13: Buttons area detail

**2.6.7 LED / buttons**

**2.6.7.1 Power button**

Power Button turns the C6 P33 BM on or off without fully disconnecting power supply. This button acts as the common power button available on all ATX PC's. It invokes the operating system to do a previously specified action, like power down or sleep.

If the operating system has been put in shut down mode and the main power has not been removed, then this button can be used to power up again the device.

**2.6.7.2 System reset button**

This button forces an internal reset. C6 P33 BM restarts as if power was loss and then turned on again. Avoid the use of this button because the immediate interruption could cause data loss, and the operating system itself could also be compromised. Use this button only if system hang and there are no better options like keyboard or mouse commands.

**2.6.7.3 Watchdog rest button**

This button turns off the watchdog LED, which is turned on when the timer expires. Otherwise, if the LED turn on, it will remain on until the power is turned off. Pressing this button turns off the watchdog LED, so if the timer expires again it can be noticed by a new turn on of the LED.

**2.6.7.4 Factory default rest button**

Use this button to reload the factory defaults of the PLC module.

**2.6.7.5 PWR LED**

This bicolor LEDs is used to give information about the power state of the system.

System power state	Green	Yellow	Notes
OFF	OFF	OFF	The system is not powered.
Power supply only ON	OFF	ON	It is safe to turn off power supply. Operating system shutdown procedure is terminated.
Full nn or Suspend to RAM	ON	OFF	System core is full on or it is in a low power state keeping current session information into RAM.

*Table 1: PWR LED*

## 2.6.7.6 UPS LED

The bicolor LEDs is used to give information about the UPS or micro-UPS functionality.

System power state	LED color	Notes
OFF	Green off	No micro-UPS installed.
	Yellow off	
Normal	Green on	System is powered from external 24VDC.
	Yellow off	
Backup not working	Green off	Micro-UPS: charging capacitors.
	Yellow on	
DC loss	Green on blinking	The external 24VDC is loss and the system is powered from the UPS. Battery/Capacitors level is above 50%.
	Yellow off	
DC loss	Green off	The external 24VDC is loss and the system is powered from the UPS. Battery/Capacitors level is under 50%.
	Yellow on blinking	

Table 2: UPS LED

## 2.6.7.7 OT/LB LED

This LED notifies two situations:

•	Fixed red color means there is an overtemperature.
•	Blinking red means that the Real Time Clock battery is low.

## Overtemperature

This LED is turned on to fixed red when there is a thermal alarm coming from inside C6 P33 BM. Two temperatures are measured by mean of Super I/O hardware monitor integrated circuit:

•	On motherboard close to CPU temperature.
•	On motherboard temperature at the input aeration.

Measuring point	Thermal limit
CPU	100°C
Motherboard	80°C

Table 3: OT/LB LED

In case this LED is fixed red, check cooling and power consumption.

## Battery low

This LED blinks red when the Real Time Clock Battery is lower than 2,5V. In such case replace the RTC battery before going down to 2V because at such voltage there could be loss of date and time.

**SYSTEM DESCRIPTION**

**2.6.7.8 WD LED**

This LED is used to notify that Watchdog timer has expired. In addition, depending on setting of SW4-4 dip-switch, as the Watchdog timer expires a system reset may occur or not. This LED may be reset to OFF state pressing WD RST button.

**2.6.7.9 LAN LED**

LED Reference	Color	LAN	Function	Additional notes	
LED left	Green	LAN1	Link/Activity	On:	link established
		I210		Blinking:	data transfer
				Off:	no link
LED right	Yellow	LAN1	Speed	Yellow on:	1 Gbps
	Green	I210		Green on:	100 Mbps
				Off:	10 Mbps

*Table 4: LAN LED*

**2.6.8 Power Supply / Earth screw**



1 | Power supply area

*Figure 14: Power supply area*



## 2.6.9 Battery CR2032 3V

**⚠ DANGER****Risk of explosion!**

If the battery is replaced with an incorrect type.

Dispose of used batteries according to the instructions.

2.6.10 CFast

The system can optionally accommodate a CFast trough a push connector.



1 CFast

Figure 16: CFast slot detail

**NOTICE**

Only use KEB approved CFast cards for industrial application. All the CFast cards intended for other uses (digital cameras, consumer products) do not have the endurance, the performance and the security features (as data reliability in case of a sudden power-off) required for an industrial application.

**NOTICE**

Removing the system memory card while the project is running. If you remove memory card while a project is running, the project may stop.

**NOTICE**

Potential data loss  
Do not remove the memory card while data is being accessed. Data on the memory card is lost if you at-tempt to remove it while the system is ac-cessing its data.

2.6.11 Mass Storage

CFAST	1 x bootable CFAST SATA II embedded on board with external access
Internal SSD mSATA	(alternative to 2,5"), 1 x mSATA SATA III internal connector for direct insertion of mSATA SSD
Internal 2.5" HDD	(alternative to mSATA), 1 x SATA III connector for HDD 2,5" with installation kit (also 24x7)
Internal 2.5" SSD	(alternative to mSATA), 1 x SATA III connector for SSD 2,5" with installation kit

Figure 17: Mass storage

2.6.12 Add-on interfaces (optional)

The system can optionally and alternately integrate the following interface:  
 1 x RS232/422/485 (DB15M) isolated ▪ 1 x USB 2.0

2.6.13 Labels position

On the lateral panel the following label is present:



1	Model
2	CE marking
3	Serial number
4	COMBIVIS connect license
5	COMBIVIS HMI license

Figure 18: Labels position

## 3 Installation and connection

### 3.1 Preparation for installation

#### 3.1.1 Select the mounting location

- Avoid direct sunlight exposure.
- Make sure that C6 P33 BM is properly (ergonomically) accessible to the operator.
- Choose a suitable mounting height.

### 3.2 Checking the package contents

- Check the package content for visible signs of transport damage and for completeness.
- In the case of damaged parts, contact your KEB representative. Do not install parts that were damaged during the shipment.

### 3.3 Checking the operating conditions

- Read carefully the standards, approvals, EMC parameters and technical specifications for operation of the device. This information is available in the following sections:
  - a) Certificates and approvals.
  - b) Electromagnetic compatibility .
- Check the mechanical and climatic ambient conditions for operation of the device.
- Follow the instructions for local use of the device.
- Adhere to the permissible rated voltage and the associated tolerance range.

### 3.4 Mounting position

C6 P33 BM device is suitable for wall book mounting installation.

### 3.5 Damage due to overheating

- All C6 P33 BM systems are designed for vertical position mounting.
- The ambient temperature must be between 0°C to +50°C measured 5 cm from all openings of the system where there is air entrance.
- Provide space around the system for air recirculation and heat ex-change.
- Mounting angle:
  - a) The system is intended to be mounted vertically.
  - b) For other installation modes contact KEB.



---

For installation in control cabinets and, in particular, in closed containers, make sure the recommended ambient temperature is maintained.

---

### 3.6 Dimenstions

#### 3.6.1 C6 P33 BM

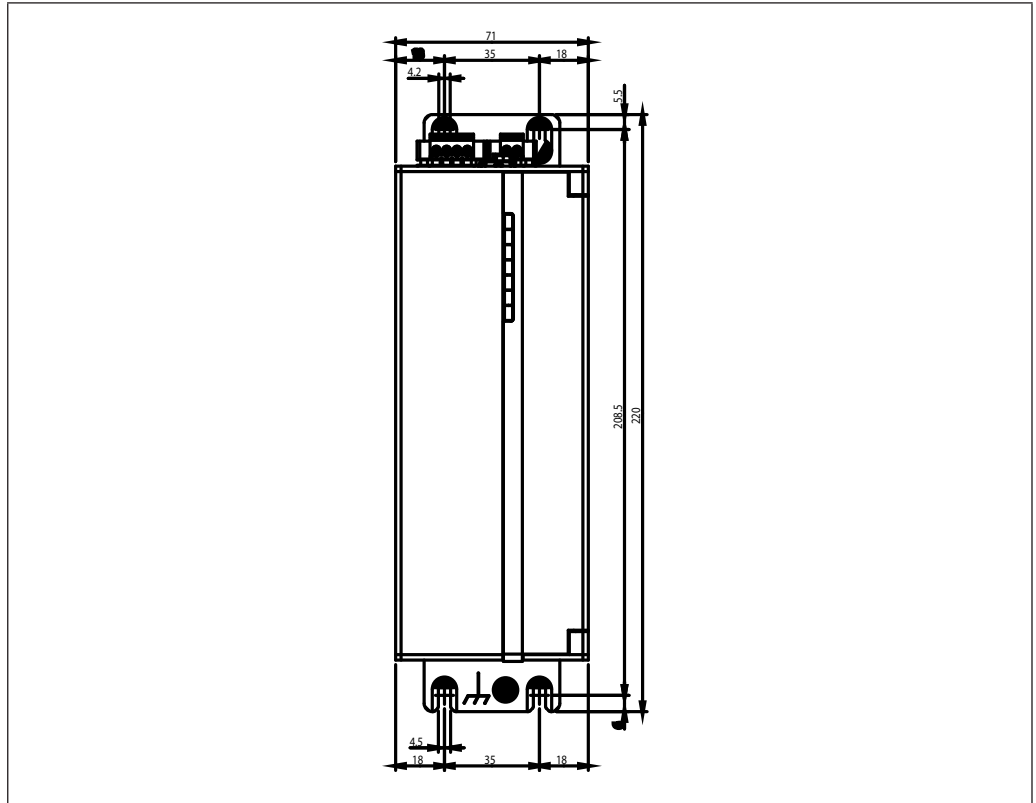

Figure 19: C6 P33 BM

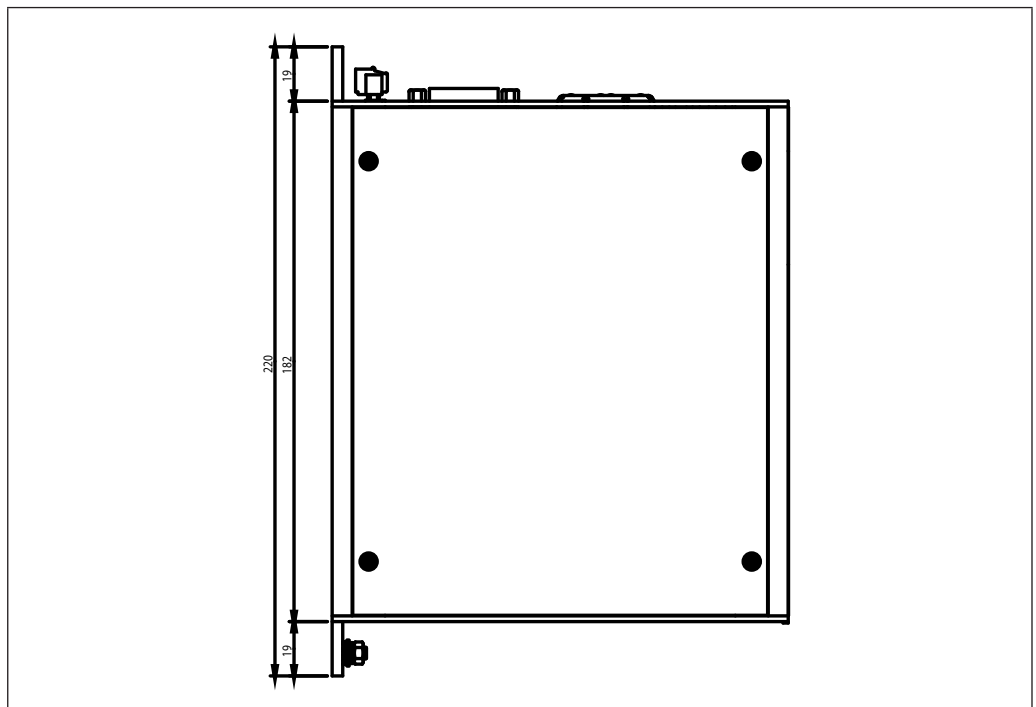



Figure 20: C6 P33 BM

### 3.7 Mounting the device

The system can be installed on a panel/wall as follows:

Tool required	Action
	
Cross screwdriver 2.5 mm	Screw / unscrew n.4 fixing screws

- Drill the required holes on the housing panel/wall according to the instructions detailed in paragraph 3.5 Di-mensions.
- There are 4 fastening points. Fastening can be made using stainless steel screws M4x20.



Figure 21: Wall mounting procedure

- Hang the system as shown in the picture.
- First lift and insert the top.



Figure 22: Wall mounting procedure

- Align the bottom.



Figure 23: Wall mounting procedure

- Release the top to match the slots with the screws.



Figure 24: Wall mounting procedure

- Tighten the four screws.



Figure 25: Wall mounting procedure

### 3.8 Grounding and bonding

Whenever two pieces of equipment connected to each other are far apart, it is possible that their ground connections could be at a different potential level. The data cable screens connecting the equipment's chassis on one end and the C6 P33 BM chassis on the other end can therefore be subject to a high current circulation capable of destroying the interface. To overcome this hazard such current must be steered away from the interface. To achieve this goal the following methods can be used:

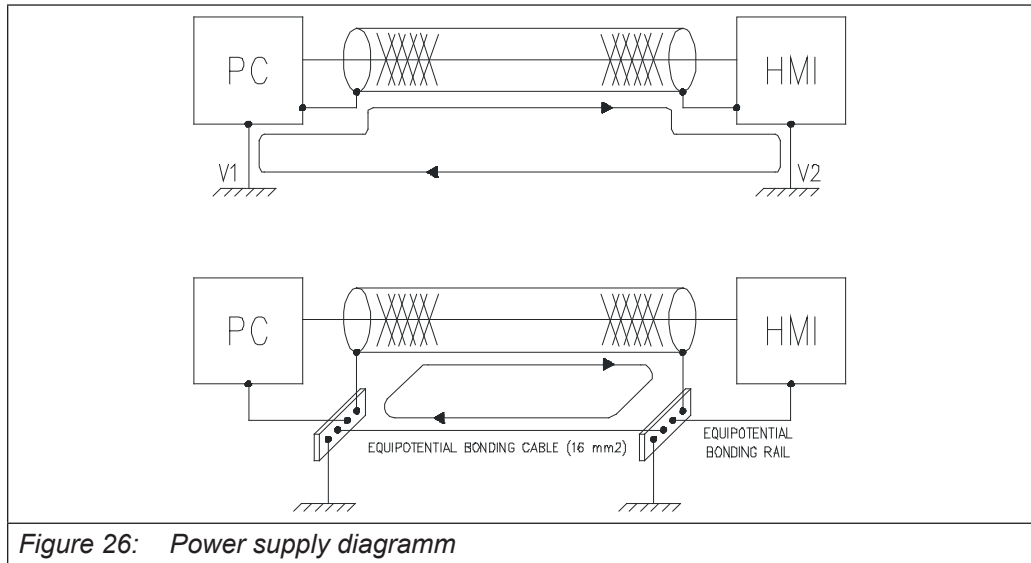

1. Use an equipotential bonding cable (16mm<sup>2</sup>) to connect the equipment ground to the C6 P33 BM ground.
2. Connect the data cable screens to the equipotential bonding rail on both sides before connecting the cable to the interfaces.

Insert the earthing eyelet terminal between the washers in the following sequence:

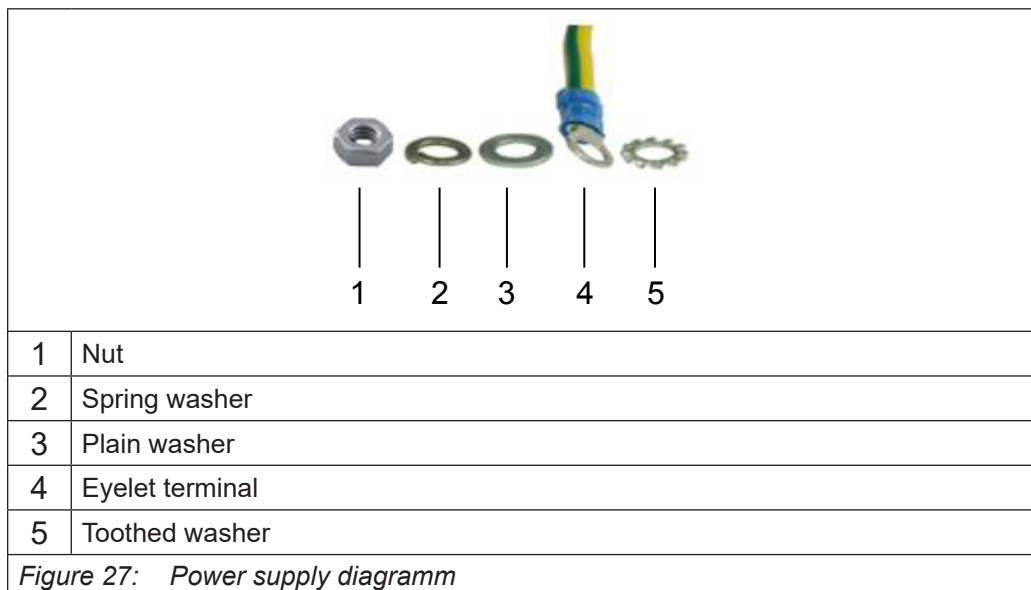





Figure 28: Grounding detail

- Tighten the four screws.

### 3.8.1 Power supply insulation

The BM2200C6 P33 BM power supply is galvanically isolated which means its output is electrically separated from its input. This feature has many benefits:

- Increases the noise immunity of the system.
- Avoids input short circuits in systems with the power supply grounded.
- Breaks ground loops which may cause interferences in the video signals.

### 3.8.2 Wiring diagram

The wiring diagram shows a simplified pictorial representation of the electrical circuit. It shows the components of the circuit as simplified shapes, and the power and signal connections between the devices.

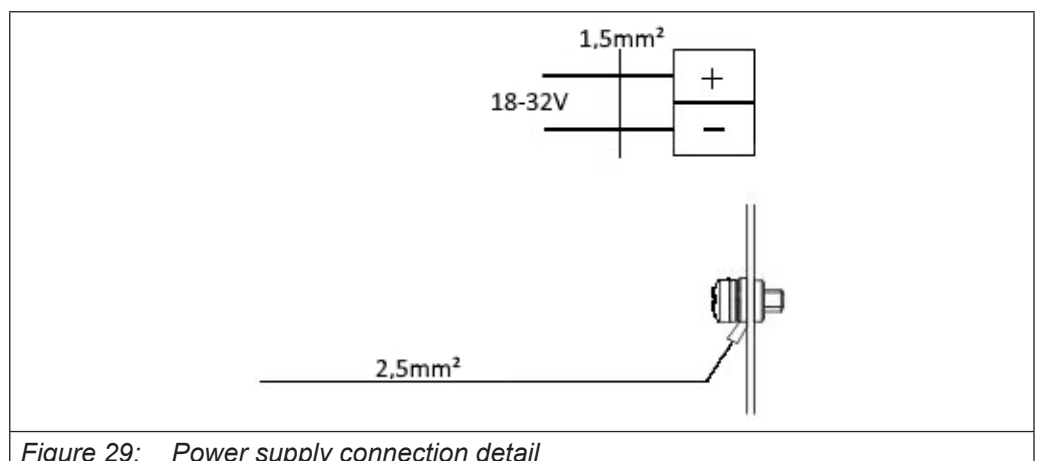

Figure 29: Power supply connection detail

### 3.8.3 Power connection assembly

The system is equipped with a connector cup to be installed on the two poles power connector. To properly assemble the connector please follow these instructions:

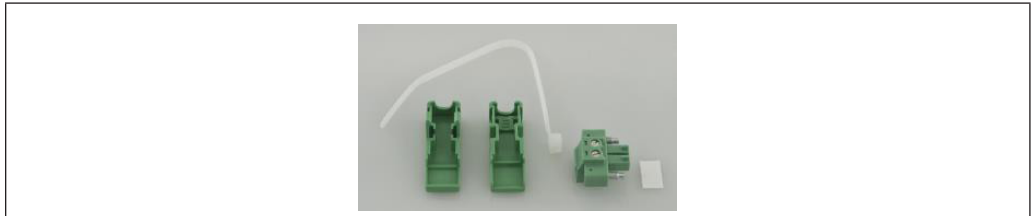

Figure 30: Power connector assembly

- Insert the cable tie in the cup as shown in the picture.

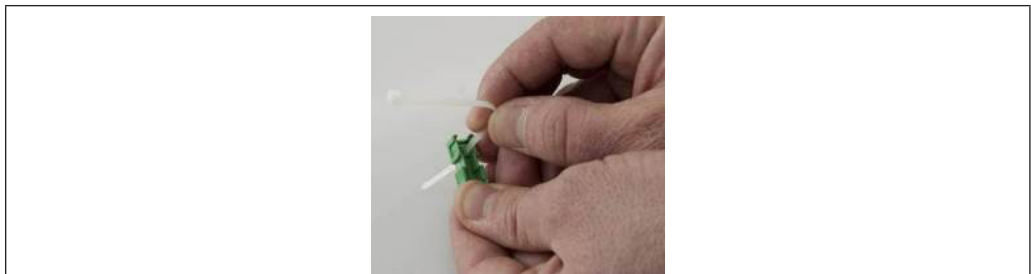

Figure 31: Power connector assembly

- Slide the cable tie as shown in the picture.

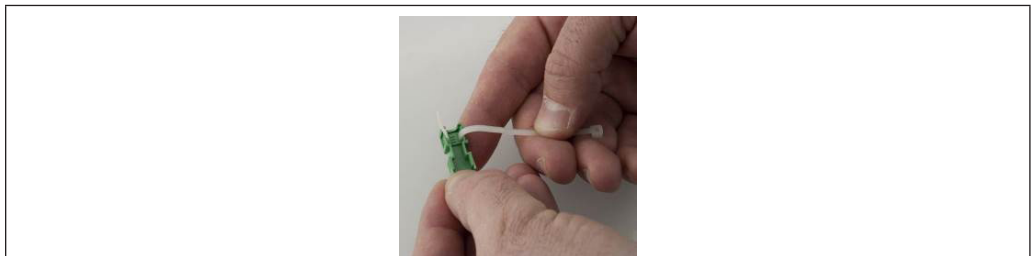

Figure 32: Power connector assembly

- Place the two poles plug connector in the cup as shown in the picture.

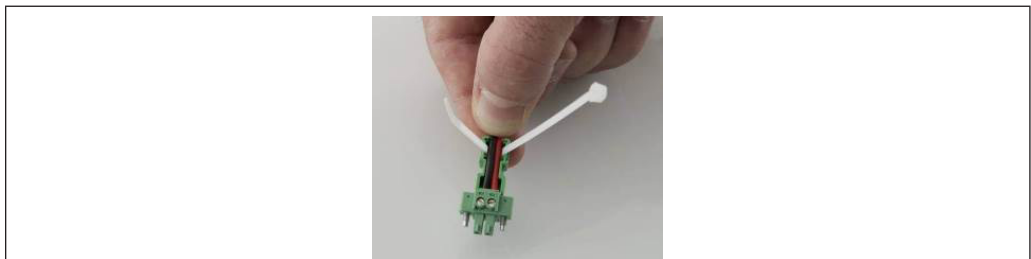

Figure 33: Power connector assembly

- Tighten the cable tie.

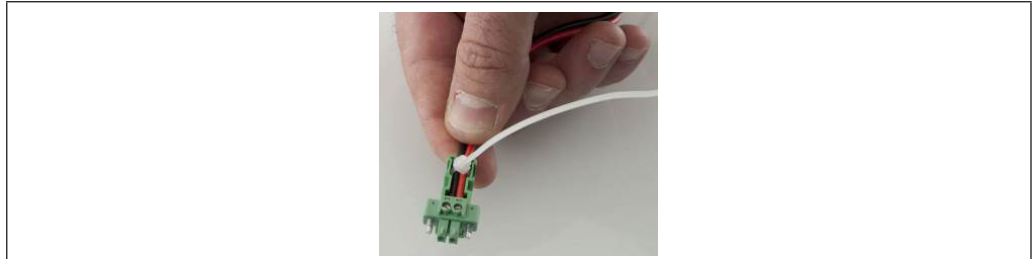

Figure 34: Cup installation

- Cut the excess part.

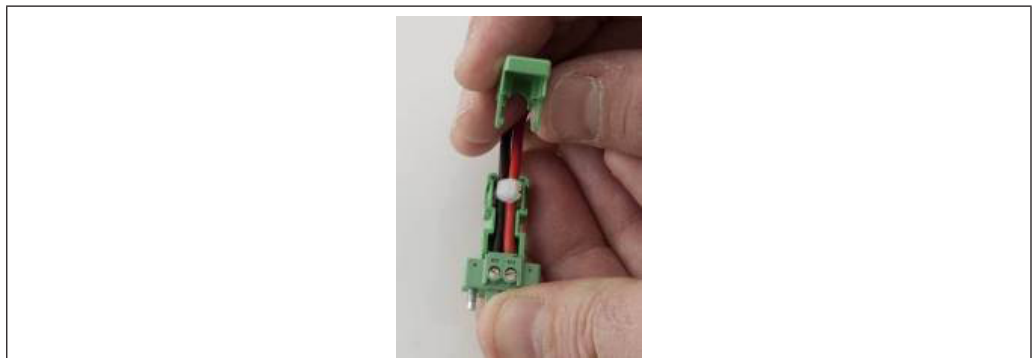

Figure 35: Cup installation

- Insert the white label and close the cup as shown in the picture.

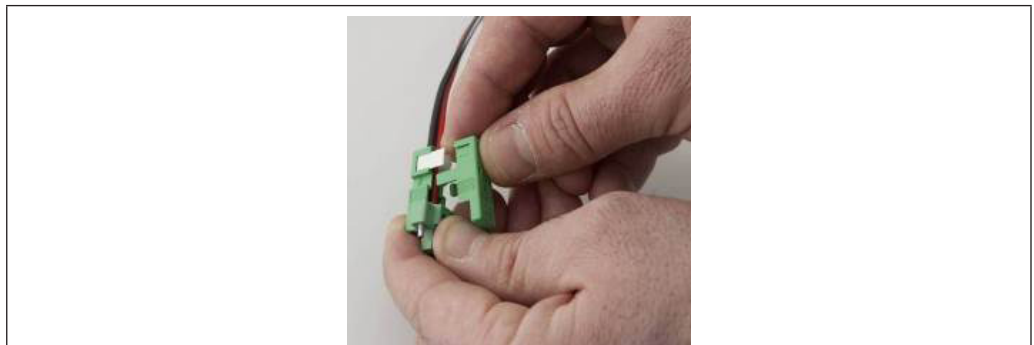

Figure 36: Cup installation

- Example of a correctly installed cup.

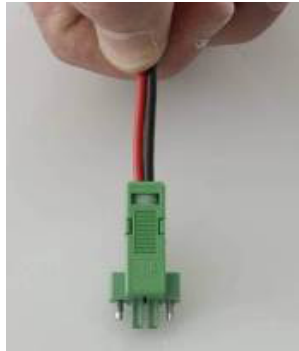

Figure 37: Power connector assembly

### 3.8.4 Power on

The system has to be connected to a 24 V (18-32V) power supply which satisfies the requirements of safe extra low voltage (SELV) in accordance with IEC/EN/DIN EN/UL60950-1.

- Remove the two poles plug connector from the system (the system is shipped with the power plug connected).
- Always check that the voltage drop along the supply wiring is not excessive and the input voltage remains above the minimum required (18V) in the worst load condition.
- Connect the ground cables (PE) to the earthing points.



Figure 38: Screwdriver detail

- Connect the positive and the negative poles (also refer to the label on the back of the system) to their respective terminals of the two pole plug connector. Use wires with a cross-section of 1.5 mm<sup>2</sup> (AWG16).



Figure 39: Power on sequence

- The system begins bootstrap.

### 3.9 Shutdown

To shut down the system please follow the standard procedure of your operating system. After power down procedure is completed, the system will be put in a soft-off state, front side led will become yellow, and the user will be allowed to switch off power supply to the system. In this state the system will dissipate negligible power.

# 4 Operating Systems

## 4.1 KEB Windows Images (Windows Embedded Standard 7 / Windows 10)

### 4.1.1 Introduction

KEB has created a "Windows Embedded Standard 7" (WES7) / Windows 10 (Win10) image for C6 E22 / C6 P3x with special features that support the work with the devices.

### 4.1.2 User Accounts

There are two user accounts implemented in the KEB image: AutoLogon and remote. The following table shows the details for the accounts:

Account	AutoLogon	remote
Administrator	Yes	Yes
Password	No	remote
Remote access	Not possible	Yes
Intention	Automatic logon after reboot	Remote Desktop connection

*Table 5: User Accounts*



**The default password for "remote" account should be changed to an individual password for security reasons.**

The AutoLogon should be continuously used as the standard logon, because only a logon without password reaches immediate start of Control and HMI application after boot of the device, which is generally the desired behavior for a machine control device. Since in WES7 / Win10 a remote logon as account without password is not possible, there is no security risk regarding the missing password for AutoLogon.

Of course own user accounts can be created, but this is not the default approach destined by KEB.

### 4.1.3 Ethernet Address

The C6 E22 / C6 P3x are configured to obtain an IP address from a DHCP server. If no DHCP server is available in the network the device uses the IP address 192.168.0.100. Thus it is also possible to connect directly to the device without a network infrastructure with a development PC by configuring the Ethernet adapter of the development PC with another 192.168.0.xxx address.



Switching to the IP address 192.168.0.100 by the device can take several minutes because the device waits this time for the possible DHCP address assignment.

#### 4.1.4 Usage of storage memories

The C6 E22 C6 P3x is delivered with two hard disk drives, a SSD and a CFast card. In Win7 Image the SSD is divided into two volumes C:\ and D:\ of its half size each. On C:\ the Operating System and the runtimes (Control, HMI, Connect) are located. D:\ is reserved for future use.

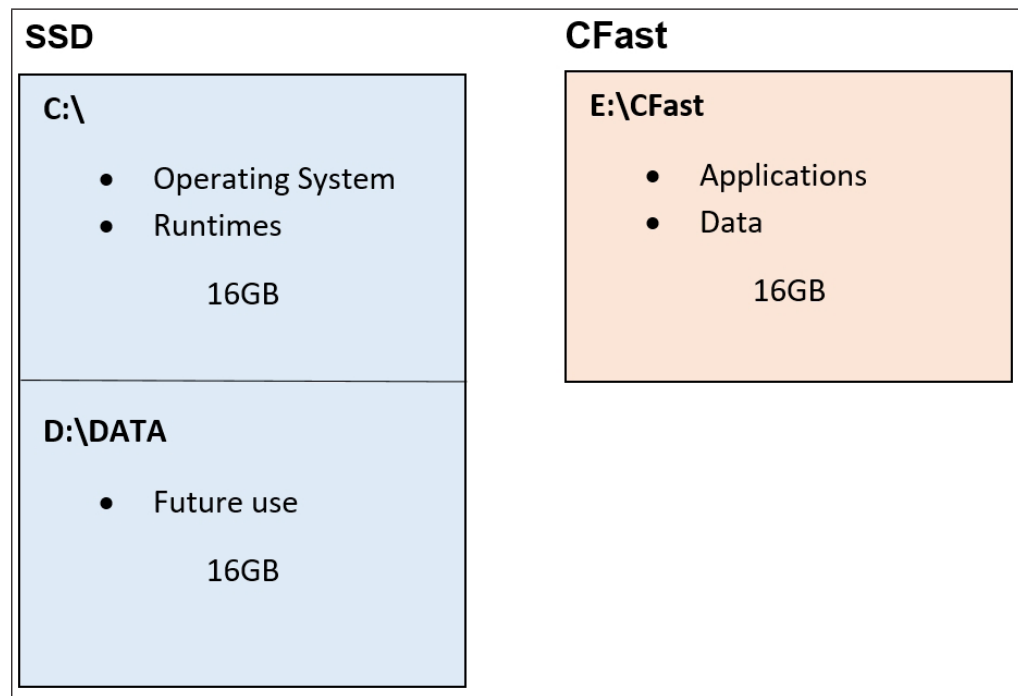

The SSD is not divided in Win10.

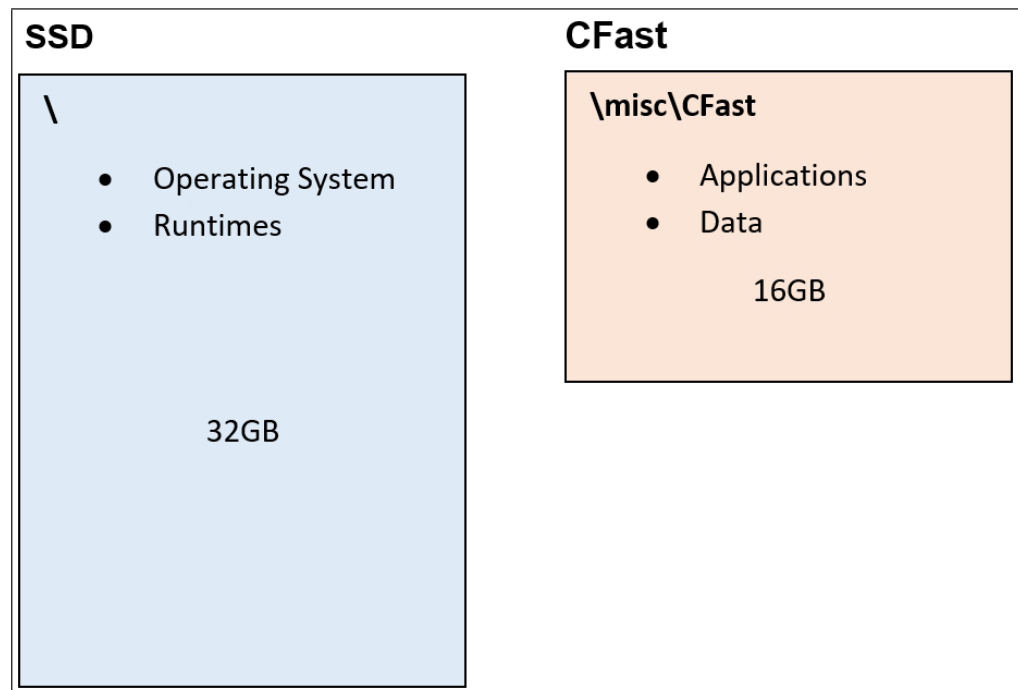

The applications and data are separated and located on the CFast (E:\). Since the CFast is easy to remove, the applications can easily be transmitted to an exchange device.

### 4.1.5 Firewall

The Windows-firewall is enabled in the delivery state. This protects the device against many types of network based attacks. KEB has configured the Windows firewall that all foreseen network connections are allowed. The Control runtime and the HMI runtime are allowed to open all network ports because for both programs a rule in the firewall exists.



This is the recommended way to configure a firewall: allow (trusted) programs to open any port instead of allow ports to be opened by any program.

However, in case of assumption that the firewall blocks desired network communication there is an easy way to disable the firewall completely for testing. On the desktop you find a "FirewallDisable" shortcut which does this and also a shortcut for enabling the firewall again.

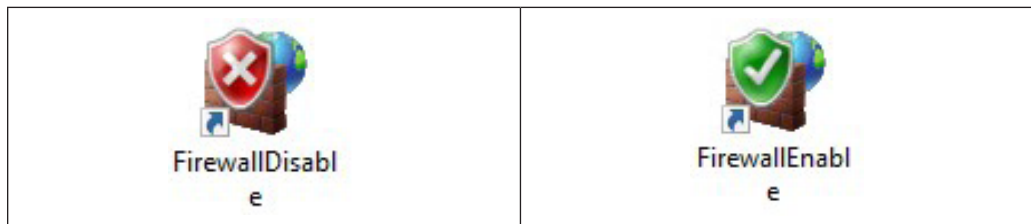

The commands need "elevated rights". Confirm the question from the User Account Control with "Yes":

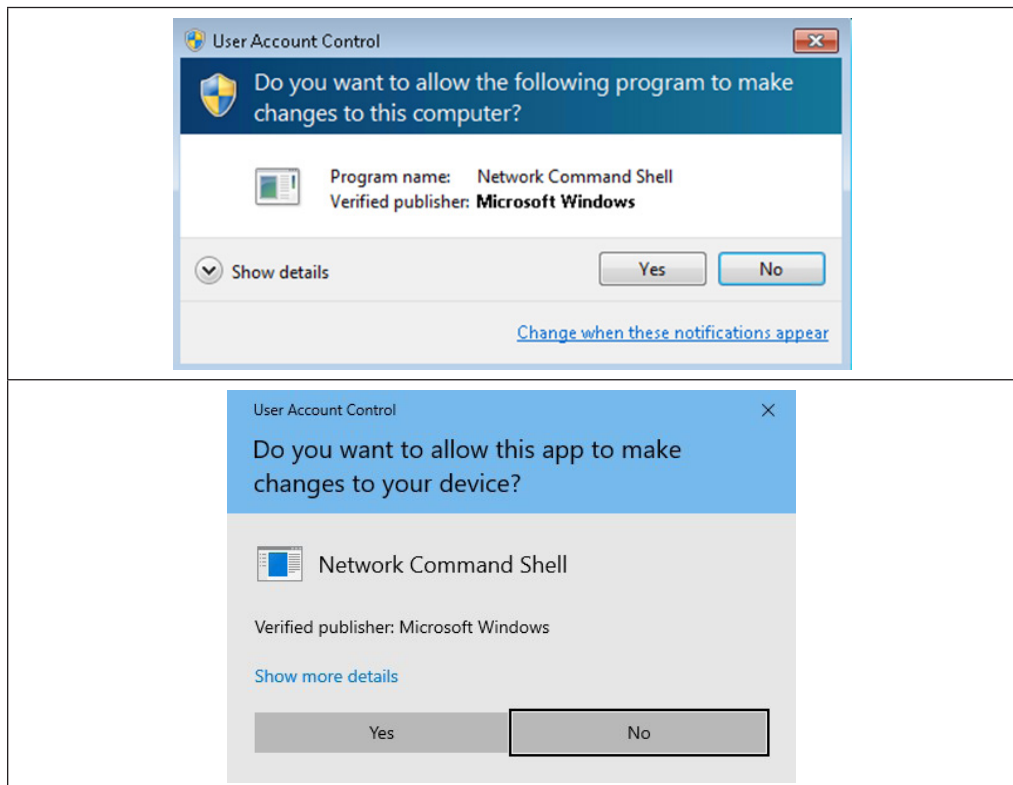



**NOTICE**

It is not recommend to disable the firewall permanently. If the test with disabled firewall confirms that the desired network communication is possible, an appropriate rule should be implemented in the firewall configuration (preferred for a program instead of a port) and the firewall should be activated again. How to implement firewall rules can be referred on the appropriate web sites from Microsoft for Windows 7 / Windows 10.

**4.1.6 eGalax Touch Driver**

The eGalax driver is installed on all C6 E22 / P3x devices, except the panel devices with capacitive touch. This driver supports all touch controllers of C6 E22 / P3x panel devices and external C6 monitors from KEB. But it does not support Multi-Touch functionality. Multi-Touch functionality is only possible with capacitive panel devices and requires the WES7/Win10 internal Microsoft Touch driver.

This driver, in turn, is not able to operate resistive touch displays. The following table gives an overview:

	<b>Resistive</b>	<b>Capacitive</b>
<b>Single Touch</b>	eGalax driver	eGalax driver
<b>Multi-Touch</b>	Not possible	Microsoft touch driver

The appropriate driver is installed on C6 E22 / C6 P3x panel devices. For Box and Bookmount devices, this preselection could not be done at the factory because the used external C6 monitor is not known at the time of production. Thus the eGalax driver is installed on those devices. If they are used in combination with capacitive C6 monitors (and Multi Touch functionality is desired at all) it is necessary to uninstall the eGalax driver. The Microsoft touch driver becomes active than automatically after 2 reboots. To uninstall the eGalax driver you find an “eGalaxUninstall” desktop shortcut which does this and also a shortcut for installing the eGalax again.

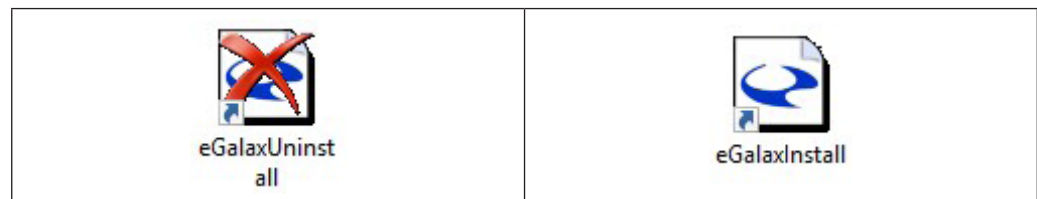

Since the used touch technology is predetermined for C6 E22 / C6 P3x panel devices, the desktop shortcuts are not placed on the desktop on these devices.

The commands need “elevated rights”, thus please confirm the question from the user account control with “Yes”:

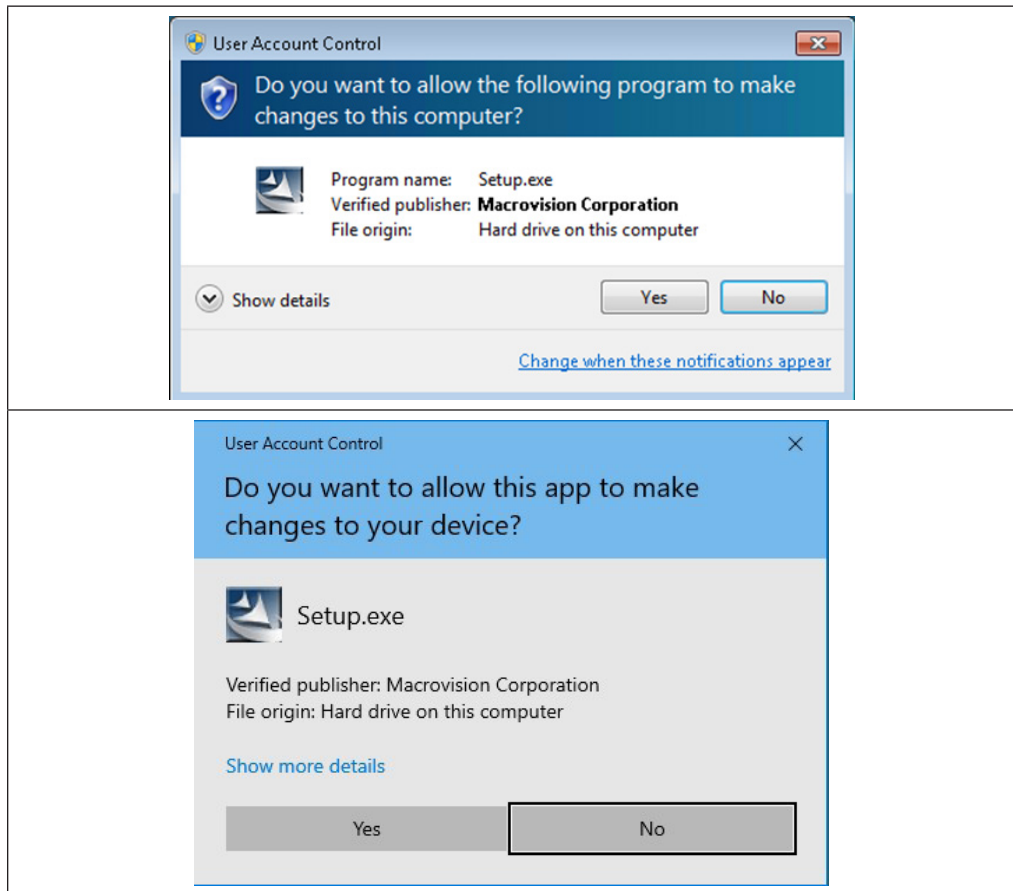

Reboot the device twice finish the switch to the Microsoft driver.

## 4.2 Windows Updates

The Windows Update service is disabled by KEB because it influences the realtime behavior of the system.

KEB recommends to enable the Enhanced Write Filter (EWF) for volume C:\ to protect the operating system against any change and damage in productive phase, thus windows updates would be discarded anyway.

### NOTICE

**Necessity of windows updates for security reasons depends on an overall concept of security for the field of application and is the responsibility of the user of this device.**

## 4.3 EWF implementation in the Windows Embedded Standard 7 images

All the KEB Windows Embedded Standard 7 images have a built-in support for Enhanced Write Filter (EWF).

EWF protects a volume from write access.

Its two major components are the EWF overlay and the EWF volume:

- **EWF Overlay:** EWF protects the contents of a volume by redirecting all write operations to another storage location. This location is called an overlay. An EWF overlay can be in RAM, or on another disk partition. An overlay is conceptually similar to

a transparency overlay on an overhead projector. Any change that is made to the overlay affects the picture as it is seen in the aggregate, but if the overlay is removed, the underlying picture remains unchanged.

- EWF volume: In addition to the EWF overlay, an EWF volume is created on the media in unpartitioned disk space. This EWF volume stores configuration information about all of the EWF-protected volumes on the device, including the number and sizes of protected volumes and overlay levels. Only one EWF volume is created on your device, regardless of how many disks are in the system. If your media does not support multiple partitions, you can save the EWF configuration information in the system's registry (RAM Reg Mode, KEB's choice)

EWF was configured by KEB with the RAM Reg Mode to protect the C: volume. So, the overlay is in RAM and the EWF volume location is in system registry.

If EWF is activated, each write operation for C: is redirected to an overlay in the RAM memory. no data will be permananetly stored into C.

In case of a reboot or of a system restart after a power failure, the overlay will be reset and all the data written in the previous session will be lost. The view of volume C: will be the same after each restart.

If no persistent volume C: is available, at least one other volume (a separate D: partition, another storage device, a network share) must be created that contains persistent data for the application.

This second volume will not be protected from power failures, but will not contain information that is vital for system booting.

On KEB Windows Embedded Standard 7 images, EWF is disabled by default at shipment and it must be enabled by the customer, in case it is needed.

## 4.4 KEB Write Filter Manager (KEB-WF\_MGR)

### 4.4.1 Introduction

KEB Write Filter Manager bases on the Enhanced Write Filter (EWF) from Microsoft for Windows Embededd Standard 7(WES7).

### 4.4.2 How EWF works

EWF protects a volume from write access. This is realized by an EWF overlay: EWF protects the contents of a volume by redirecting all write operations to another storage location. This location is called an overlay. An EWF overlay can be in RAM, or on another disk partition. An overlay is conceptually similar to a transparency overlay on an overhead projector. Any change that is made to the overlay affects the picture as it is seen in the aggregate, but if the overlay is removed, the underlying picture remains unchanged.

When EWF is enabled for a volume, every write operation to that volume will be redirected to an overlay in RAM and no data will be persistently stored into the volume. In case of a reboot or of a system restart after a power failure, the overlay will be reset and all the data written in the previous session will be lost. The view of the volume will be the same, after every reboot. Thus the content of the volume is protected by any damage which can be caused by power fails otherwise.

4.4.3 Protectable volumes

Volume	Protectable	Intention
C:\	Yes	Holds the operating system (including the registry) and the installed programs. Should be protected to ensure that the system never becomes unbootable.
D:\DATA	No	For free data storage, future use
E:\CFAST	Yes	Holds the Control and HMI applications. Should be protected to ensure that the applications never become invalid.

Table 6: Volume protection

4.4.4 KEB EWF configuration

On KEB devices RAM overlay is used and the EWF configuration is stored in the registry of the WES7 operating system, which resides with the operating system on volume C:\. This implies that changes to the EWF configuration are only possible if the EWF for volume C:\ is disabled or the changes to C:\ will be committed. Otherwise they will be discarded after a reboot. The following table shows the dependencies between the volumes:

		Registry Drive (holds the registry): C:\								
		EWF enabled				EWF disabled				
		ENABLE	DISABLE	COMMIT	NO_CMD	ENABLE	DISABLE	COMMIT	NO_CMD	
Dependent Drive: e.g. E:\	Status	(Boot) Command								
	EWF enabled	Enable	in this state	for drive C:	not available in this state		for drive C:	in this state	state	
		Disable			x	-			x	x
		Commit			x	x			x	x
		Commit and Disable live			x	x <sup>1)</sup>			x	x
	EWF disabled	Enable	not available	not available	x	-	not available	not available	x	x
		Disable	not available	not available	not available in this state		not available	not available	state	
		Commit			not available in this state				state	
Commit and Disable live		not available in this state			state					

x possible  
 - not possible  
 x<sup>1)</sup> possible, but EWF enabled again after reboot



These dependencies are handled by the KEB\_WF\_Mgr internally. Therefore it is not necessary to understand this table completely or to use it as a reference when using the EWF. But keep in mind that there are dependencies because some internal operations of the KEB\_WF\_Mgr has to be confirmed by the user.

4.4.5 Delivery state of EWF on KEB devices

On KEB Windows Embedded Standard 7 image, EWF is disabled by default at shipment because some settings has to be made on the drive respective in the registry by the user (e.g. IP address setting).

Every time WES7 starts with EWF disabled for volume C:\ the user is reminded to enable the EWF by the following message box:

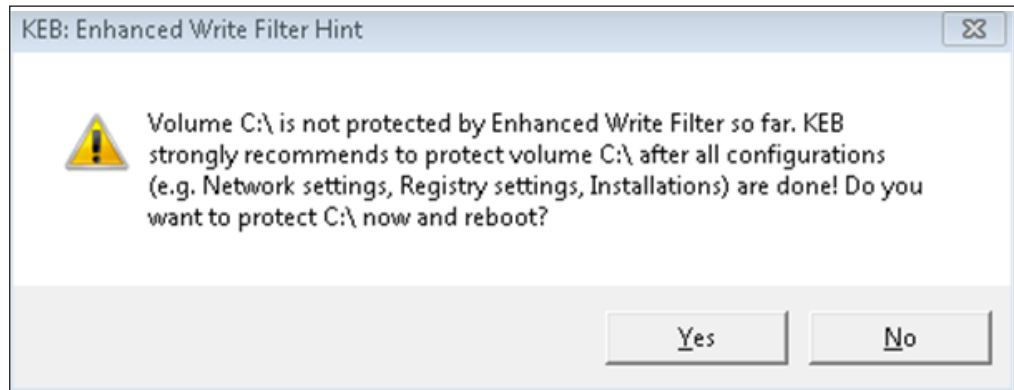

After all settings to the registry are done you can directly activate the EWF for volume C:\ by clicking 'Yes'. The device will reboot immediately and the EWF is enabled for volume C:\.

If you click "No" the message box is closed but will be appear again after the next reboot.

Please note that the volume E:\ which holds the application data is not protectable by this way.

#### 4.4.6 Using KEB\_WF\_Mgr

To disable EWF or to enable it for other volumes, KEB\_WF\_Mgr should be used (the use of the command line program "ewfmgr" from Microsoft is not recommended by KEB).

Start the KEB\_WF\_Mgr by double-click the icon on the desktop:

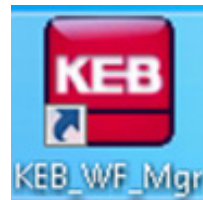

Then the desktop link will start the program which resides in the path „C:\Program Files\KEB\IPCTools“.

The program needs "elevated rights". Please confirm the question from the user account control with "Yes":

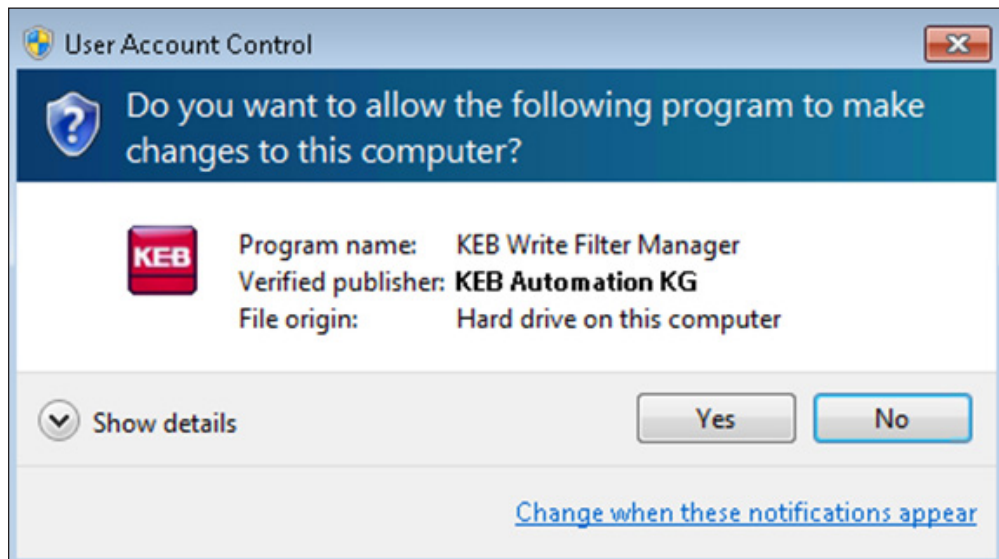

The program's GUI appears with volume C:\ (provided that EWF for volume C:\ has already been activated before).

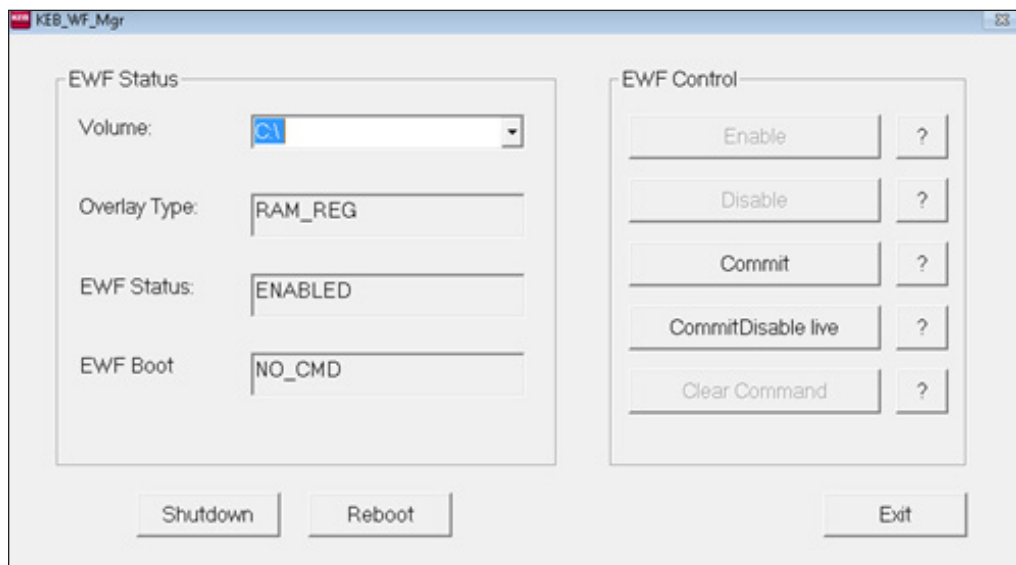

Under the Volume: you see the states of the selected volume as read-only fields:

- Overlay Type: On KEB devices always RAM-REG
- EWF Status: Current status of the EWF
- EWF Boot: Command which will be performed with the next reboot

On the right side you see the EWF control commands, each with a help button aside (the commands which are not available in the current constellation are greyed and disabled):

- **Enable:** Enables a currently disabled overlay on the specified EWF-protected volume. This function requires a reboot.
- **Disable:** Disables a currently enabled overlay on the specified EWF-protected volume. This function requires a reboot.



This function is not available at all for the volume C:\ which holds the registry, because the change in the registry for the new state of EWF cannot become persistent. Use 'CommitDisable live' instead to disable EWF for C:\

- **Commit:** Commits all current level data in the overlay to the EWF-protected volume. This function requires a reboot. After the reboot the EWF status of the volume is still "ENABLED".
- **CommitDisable live:** Immediately commits all current level data to the EWF-protected volume and then disabled EWF. This function does NOT require a reboot.

### NOTICE

All changes on the volume since the last reboot become effective. Do not execute this if you are not sure about the extent of the changes.

### NOTICE

The changes become effective immediately with reboot. It is not possible to undo this command with "Clear Command".

- **Clear Command:** Clears a pending command for the volume that would have occurred on the next restart.

#### 4.4.7 Dependent Volumes (typically E:\)

As mentioned above, other volumes (in the following, typically E:\ which is the CFast on KEB devices) are dependent from volume C:\ to change their configuration because they are stored in the registry located on C:\ and thus the registry is protected against any changes, if EWF is activated for C:\

If EWF is deactivated for C:\ all commands for the dependent volumes can be used independently.

Otherwise, if EWF for C:\ is enabled, the following rules are effective:

- **Enable and Disable:** if one of these commands is used the following message box asks if the commit command for C:\ should also be set. It is recommended to confirm with "Yes" because otherwise the enable or disable has no effect. The message is not displayed if the boot command for C:\ "Commit" is already present.

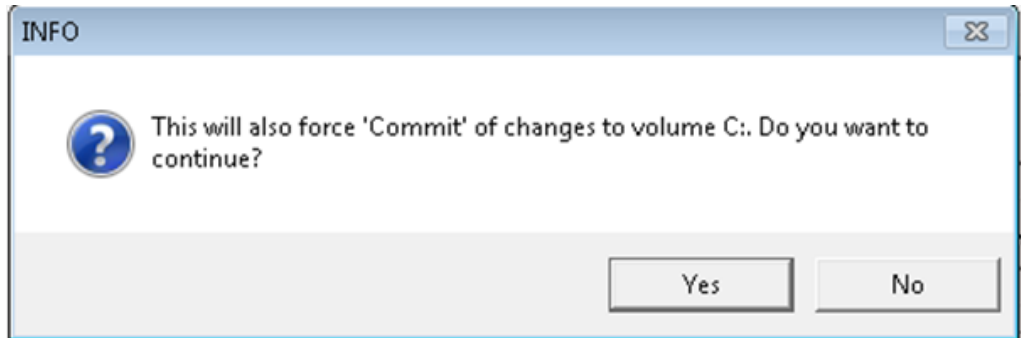

- The **Clear Command** can reset the commit without any dependency, but for Enable/Disable it asks to clear the implicitly set of commit for volume C:\, too:

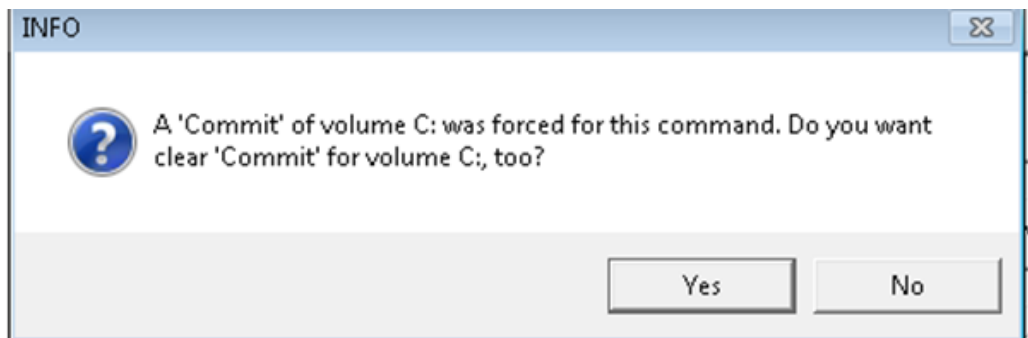

Normally you should confirm with “Yes” because the commit for volume C:\ was only set to take effect for the change of E:\.

#### 4.4.8 Leave the KEB\_WF\_Mgr

A Shutdown or Reboot of the device can be initiated directly from the KEB\_WF\_Mgr to take effect for pending boot commands by using the particular buttons.

The program can also be left by the Exit button. In this case the program checks for pending boot commands and shows if appropriate the following message box:

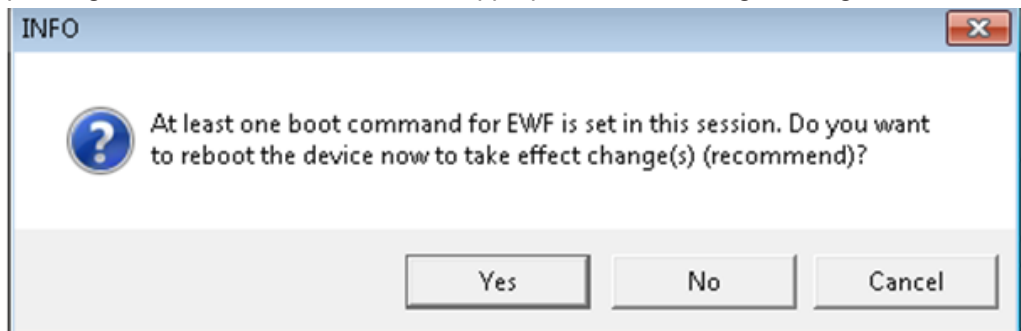

It is recommended to choose “**Yes**” to ensure that no subsequent changes of the system are committed accidentally; which could be happened if you quit the message box with “**No**”.

If you choose “**Cancel**” the exit of the program is discarded and you can continue to work in the KEB\_WF\_Mgr.



## 4.5 KEB UWF Manager

### 4.5.1 Introduction

The KEB UWF Manager offers a simple interface to use Microsoft's Unified Write Filter in Windows 10.

### 4.5.2 Functioning of the UWF

UWF protects your volume from write access by redirecting all write commands to a virtual overflow. The virtual overflow is a temporary memory, which is either in RAM or directly on the volume and which is cleared when the device is restarted. Any change made to the overflow affects the image, but if the change is undone, the image remains unchanged.

If the UWF is enabled for a volume, no data are permanently stored on this volume. In case of a restart or power failure, the overflow will be reset and all data from the previous session will be lost. The view will be the same after each reboot and is therefore protected against damage that can be caused by a power failure.

### 4.5.3 KEB UWF configuration and usage

To protect the system on volume C:\ including the registry, the overflow is configured with 4096 MB on the hard disk as standard.

KEB recommends the use of a write filter in order to increase the longevity of the devices and the data integrity. UWF Manager is disabled at the time of delivery, in order that the user can make changes during the start-up process.

Each time the device boots up with disabled UWF, the user is reminded to activate the write filter. As soon as the start-up is completed, the user can activate the write filter directly by clicking "Yes".

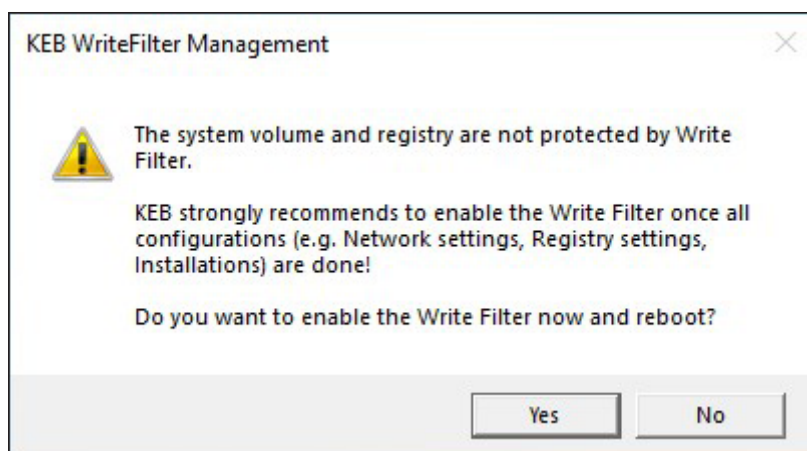

To activate the UWF Manager or to display more information about the current protection status, the KEB UWF Manager should be used, because it provides a more intuitive configuration option compared to the command line tool provided by Microsoft. A

shortcut to the KEB UWF Manager can be found on the desktop and can be executed by double click. Please note that this tool requires elevated rights, the popup window of the user account control must be confirmed with "Yes".

The program interface appears and you can protect (Protect) or not protect (Unprotect) your system. Furthermore, after activating the write filter, the overflow info (Overlay Info - Current) is displayed including type, maximum size and current usage.

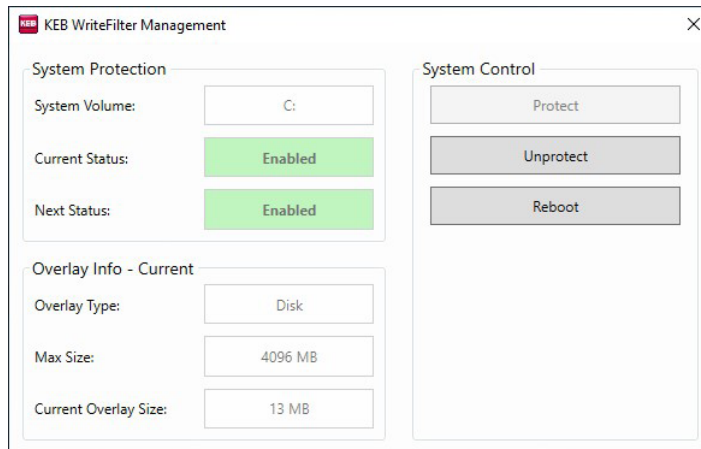
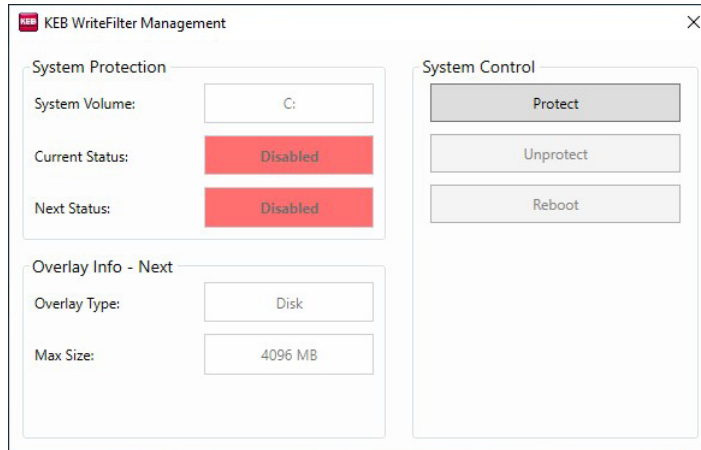

Depending on the current status of the UWF Manager, the user can protect or unprotect the system by using the buttons on the right. Both actions require a restart. If the state has changed, the "Reboot" button can be used to restart the system and to activate the set state.

In case of a state change without restart, the tool reminds the user to restart the system when leaving.

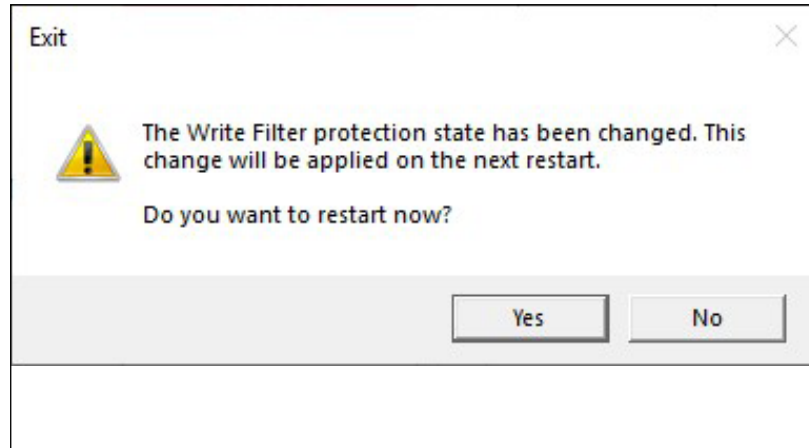

## 4.6 KEB Linux Image

### 4.6.1 Introduction

KEB has created a Linux image for C6 E22 / P3x with special features that support you in the work with the device.

### 4.6.2 Service user accounts

KEB Linux image has got a service account which can be used to change device settings.

Account	service
Password	service

After login to the device with the service user account the following menu is shown:

```
C6E22LX login: service
Password:
Last login: Tue Oct 29 10:13:22 2019
Welcome to service shell of host: C6E22LX

Please, select operation from list below:
 1) Show/change IP address
 2) Change hostname
 7) Show version information
 8) Change password
 9) Reboot PLC
 0) Exit
```

## NOTICE

The default password for the service user account should be changed to an individual password for security reasons!

The C6 E22 / C6 P3x Linux is configured to use the IP address 192.168.0.100. This also makes it possible to set up a remote connection to the device with a development PC, e.g. if no display unit is available. To do this, configure the Ethernet adapter of the development PC with another address 192.168.0.xxx and connect to the device with Putty as service user:

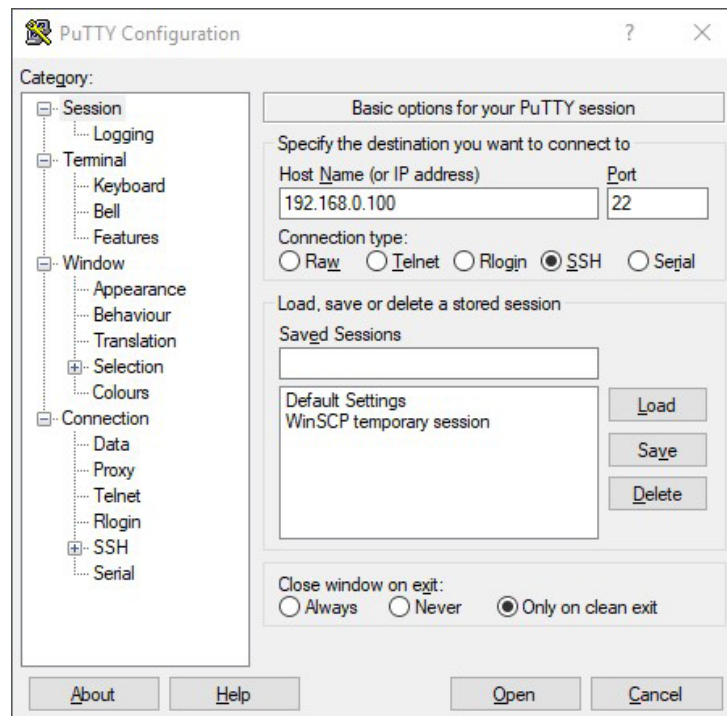

#### 4.6.3 Change password for service user

To change the password, proceed as follows:

- Login as user “service”
- Select menu “8) Change password”
- Follow the instructions:
  - Enter old password
  - Enter new password twice. It must fulfill conditions regarding length and complexity
- Reboot the device

#### 4.6.4 Ethernet IP Address

To switching the Ethernet address the service user menu “1) Show/change IP address”. The current IP address is shown and following sub menu occurs:

```
Current IP address: 192.168.0.100
Changing IP address:
  1) Switch network to DHCP
  2) Switch network to default static IP
  3) Switch network to static IP
  0) Back to main menu
```

Choices:

1.	Switch network to DHCP, to switch to dynamic network configuration (DHCP).
2.	Switch network to default Static IP, to switch to default static IP 192.168.0.100/24.
3.	Switch network to static IP for static network configuration.

The set e.g. the IP address 172.17.131.100 and the mask 255.255.255.0 must be entered as followed:

**172.17.131.100/24**

The value 24 for mask means 24 set bits in the mask beginning from left. Accordingly, 8 bits on the right are not set.

#### 4.6.5 Usage of storage memories

The C6 E22 / P3x Linux is delivered with two hard disk drives, a SSD and a CFast card. On the SSD the Operating System and the runtimes (Control, CNC Kernel etc.) are located. The applications and data are separated and located on the CFast. Because the CFast is easy to remove the applications can be transferred to an exchange device easily.

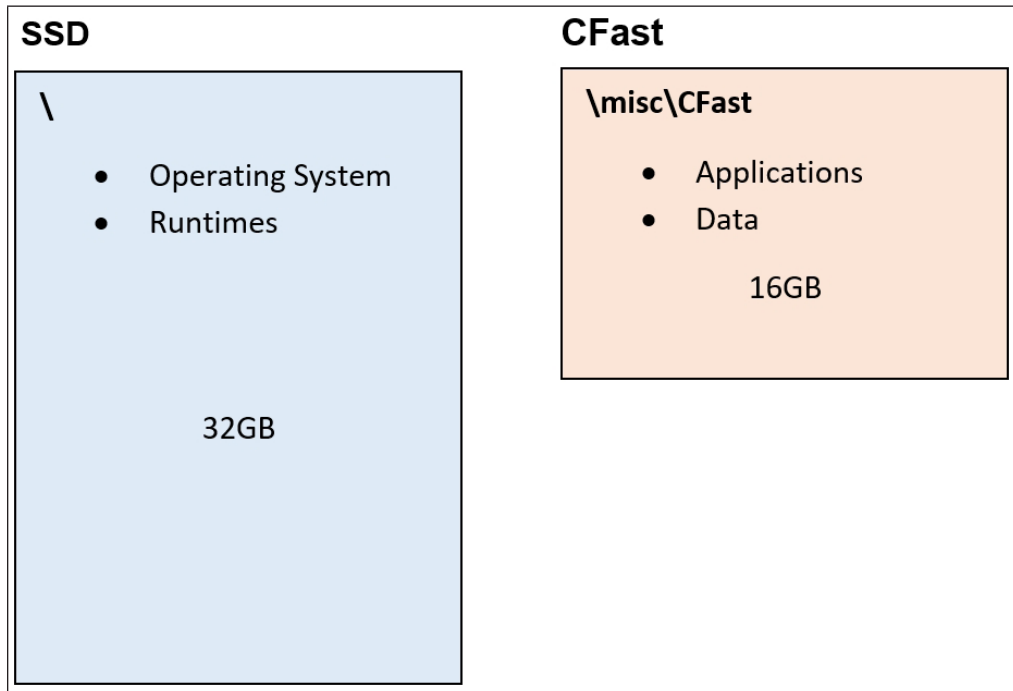

### 4.7 Common (Windows and Linux)

#### 4.7.1 Micro-UPS Handling

As also mentioned in the hardware related parts of this manual all C6 E22 / P3x devices are equipped with a micro-UPS to ensure storage of Retain and Persistent variables of the Control application in case of power lost.

To avoid inconsistent data sets, the Retain and Persistent variables will be stored only if the  $\mu$ USV is charged completely. Otherwise the capacity could not be sufficient to store all variables and the consistency of the data set cannot be ensured.

The charging time of the micro UPS is about 15 s for C6 E22 / P3x devices, thus normally the micro UPS is always charged until the Control application is started after a restart of the device. But for security and to keep the Control application easy portable to devices this longer charging time the charging level should be evaluated in the Control application.

For this an “Internal I/O Mapping” named “IoDrvUPS” is automatically available with the C6 E22 / P3x device in KEB COMBIVIS studio 6.

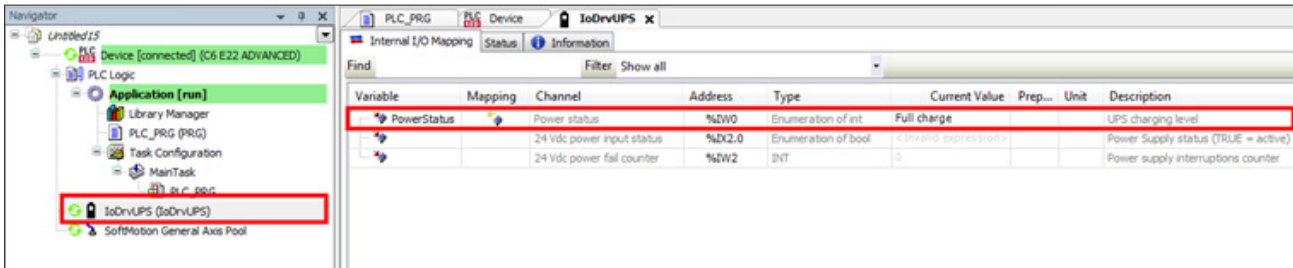

To evaluate the „Power status” inside the Control application a variable has to be defined, e.g. „PowerStatus“.

The values of Power status are:

0	Unit isn't available (must not appear on functional C6 E22 / P3x)
1	Low charge
2	Half charge
3	Full charge

The Machine application should wait until the micro-UPS is fully charged before any operation is performed which changes Retains or Persistents. This can be achieved with an implementation comparable with the following example:

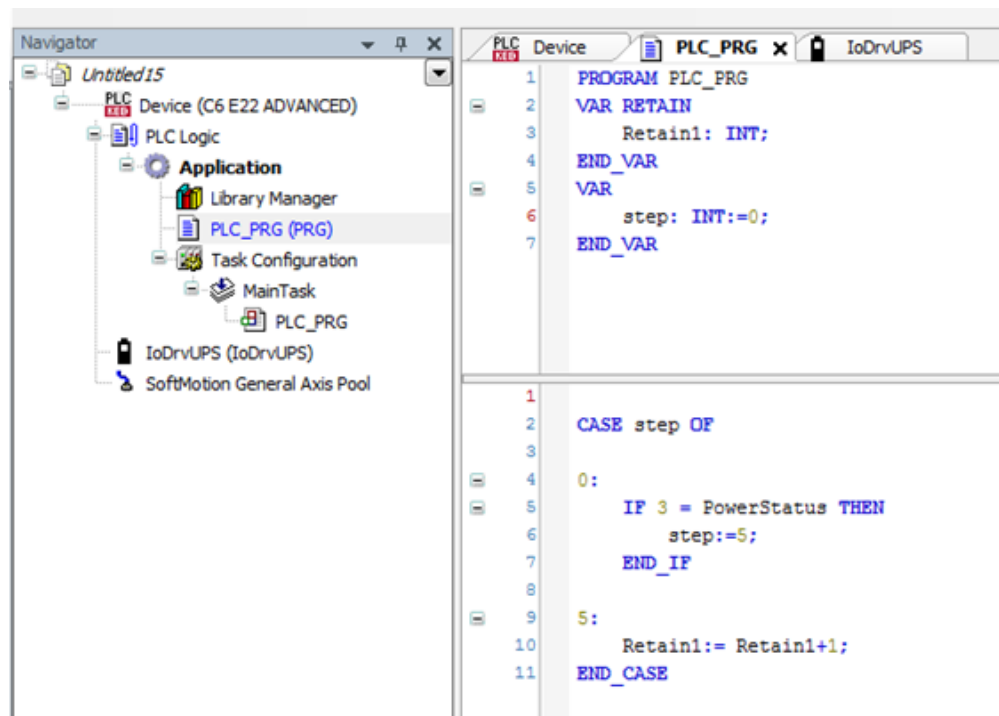

The other "Internal I/O Mapping" variables "24 Vdc power input status" and "24 Vdc power fail counter" cannot be used in a sensible manner, because the PLC is configured to stop after a short voltage drop already.

#### 4.7.2 Ip-Scan

Ip-Scan is an IP address scanner from KEB to find other KEB devices in the network. This requires that Ip-Scan runs also on the device which should be found. The C6 E22 / P3x should be detectable by the Ip-Scan (also integrated in COMBIVIS studio 6). The Ip-Scan starts automatically after booting on the device.

**Ip-Scan is not yet available on C6 E22 / P3x Linux!**

4.7.3 Serial interface

The C6 E22 / C6 P3x can be equipped with an (optional) serial interface (COM ports). The following table gives an overview:

	C6 E22		C6 P33	C6 P34
	Bookmount	Panel/Box		
COM1	----	RS232	----	RS232
COM3	opt. RS232/ RS422/RS485	opt. RS232/ RS422/RS485	opt. RS232/ RS422/RS485	opt. RS232/ RS422/RS485

By default the COM port is configured to the RS232 protocol. RS422/RS485 is also possible for some devices.

In order to enable activate ports and to switch the protocol setting, it is necessary to enter the BIOS. This is done by pressing the "F2" key during start-up. You can change the settings by navigating to "Advanced/Super IO Configuration" for C6 E22 or "Advanced/F81866 Super IO Configuration" for C6 P3x. There you find the settings for the COM ports.



The names of the COM ports differ within the BIOS. In the C6 E22 BIOS, "COM1" is designated as "COM A" and "COM3" as "COM C". In C6 P3x BIOS, COM ports are called "Serial Port x", but with the same number.

Navigate to the "Mode" setting for the COM port and change it to "RS422" or "4-Wire RS485". Leave the BIOS with "F10" key to save the changes.

In Windows and/or the COMBIVIS studio 6 application no changes are necessary.



## 5 Maintenance and service

### 5.1 Removing the left and the right side cover

Tool required	Action
	Screw / unscrew fixing screws
Plastic screwdriver	

Turn off the system and disconnect the power supply.

On each side of the system remove the 3 fixing screws of the cover.

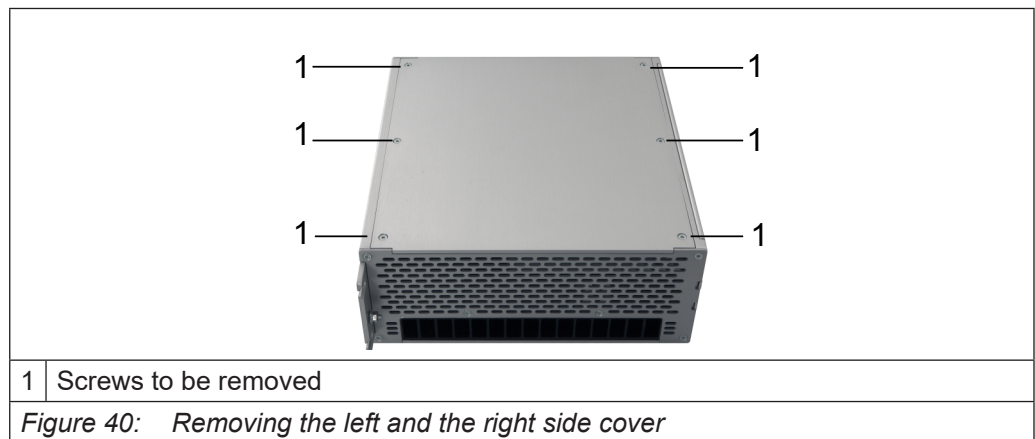

### 5.2 RAM installation / removal

Locate the RAM module.



Expel the module by slightly opening the side fastening tabs of the plinth.



Figure 42: RAM installation / removal

For reinsertion, check the correct polarity of the module. When insertion is complete, check for proper closure of the side fastening tabs.

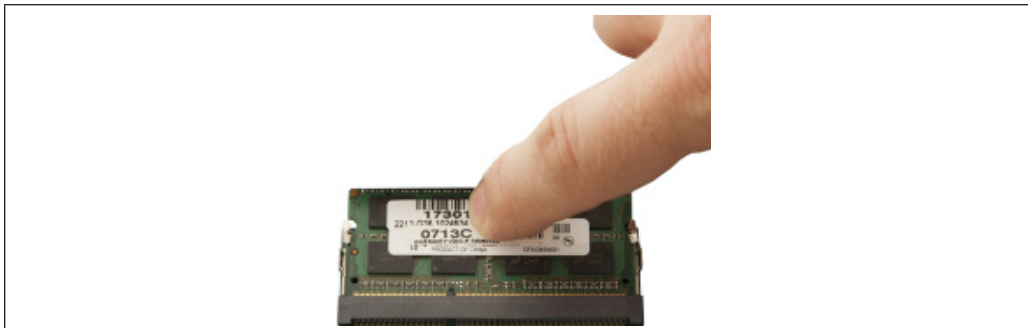

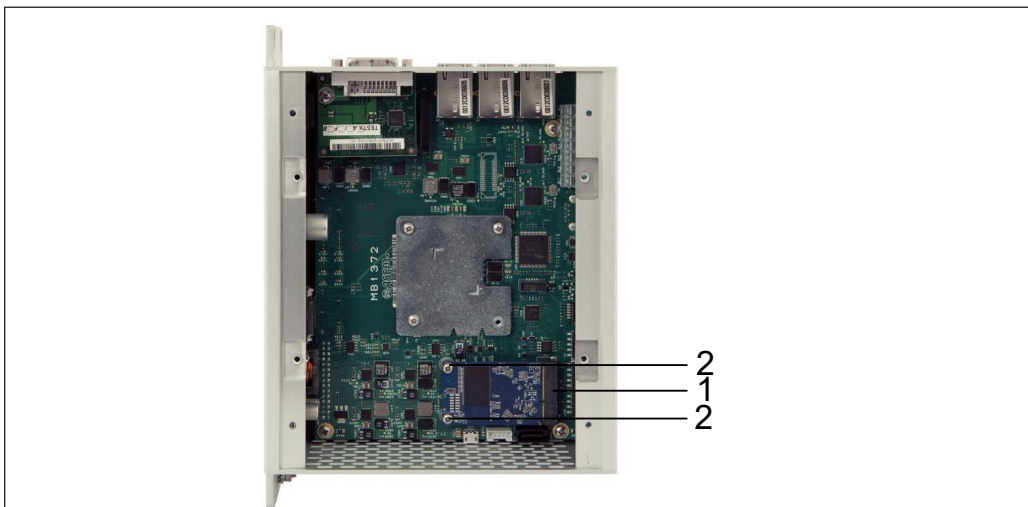

Figure 43: RAM installation / removal

### 5.3 SSD mSATA installtion / removal

Tool required	Action
	Screw / unscrew n.2 fixing screws
Plastic screwdriver	



- 1 | SSD mSATA module
- 2 | Fixing screws

Figure 44: SSD mSATA installatoin / removal

### 5.4 Battery installation / removal

Tool required	Action
	Pull the battery holder.
Plastic screwdriver	

- Turn off the system and dis-connect the power supply.
- Using a screwdriver (not provided) carefully pull out the battery holder.



Figure 45: Battery installation / removal



Figure 46: Battery installation / removal

- Remove the battery and replace it with one of the same model (Lithium CR2032 3V Coin).



Figure 47: Battery installation / removal

- Re-insert the battery holder with the new battery. Check for correct polarity.

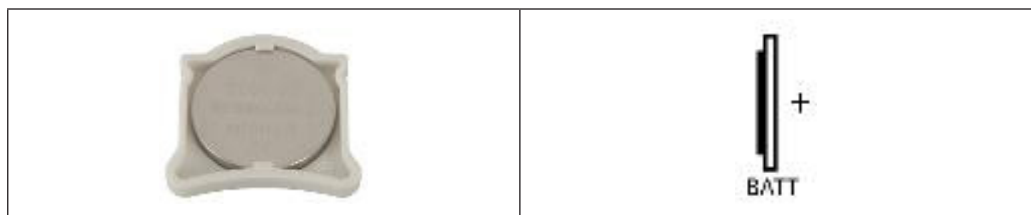

Figure 48: Battery installation / removal

## 5.5 CFast installation / removal

- Turn off the system and disconnect the power supply.



Figure 49: CFast installation / removal

- Insert the memory card into the slot as indicated in the figure. Pay attention to the beveled edge.
- Push the card all the way.

### 5.5.1 Removal

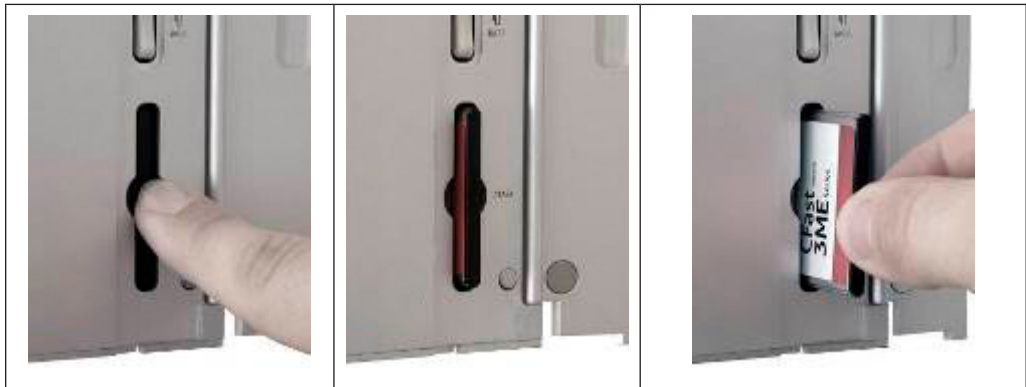

Figure 50: CFast installation / removal

- Push and release the memory card as indicated in the figure.
- Extract the memory card from the slot.

## 5.6 Maintaining and cleaning

C6 P33 BM is designed for maintenance-free operation except for the replacing of the battery backup when necessary. It is recommended to clean the touchscreen with a damp cleaning cloth and a display cleaning solution.



Clean the front panel of the system with a soft damp cloth only.

### 5.6.1 Procedure

Proceed as follows:

- Switch off the C6 P33 BM device or lock the touch screen.
- Spray the cleaning solution onto a cleaning cloth.
- Do not spray directly onto the display.
- Clean the display from the screen edge inwards.

# 6 Technical specifications

## 6.1 Block Diagram

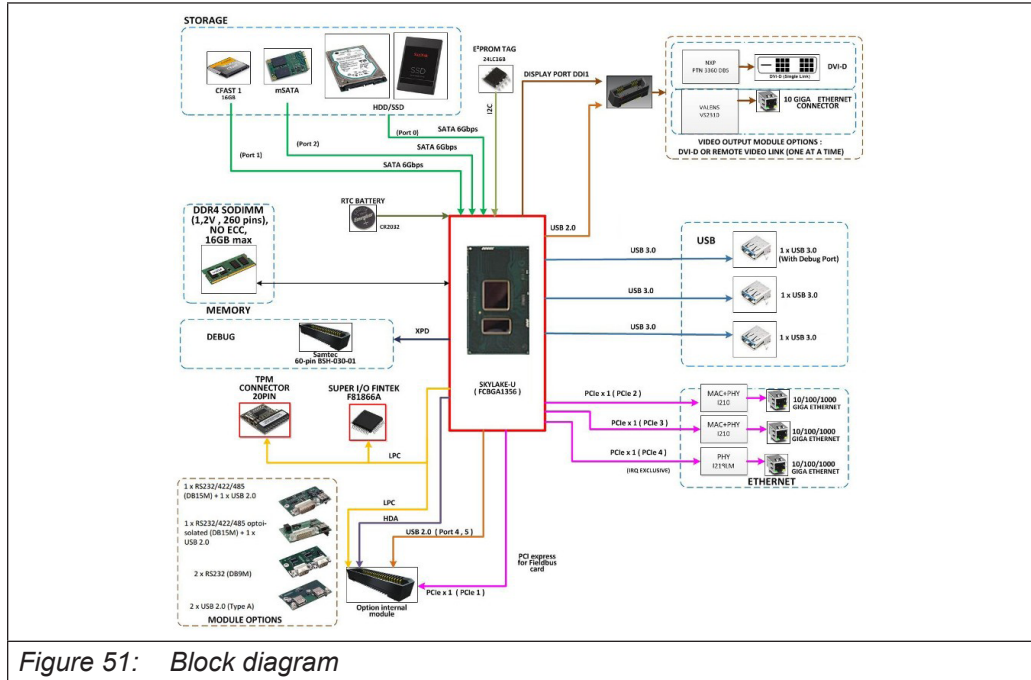

Figure 51: Block diagram

## 6.2 Technical data

### 6.2.1 C6 P33 BM basic configuration

Basic configuration	Intel® Celeron® dual core 3955U 2,00 GHz ▪ 4GB RAM ▪ fan-less ▪ DVI-D video output ▪ 24V DC isolated power supply ▪ COMBIVIS connect runtime ▪ 12 month warranty
---------------------	--

### 6.2.2 C6 P33 BM RVL basic configuration

Basic configuration	Intel® Celeron® dual core 3955U 2,00 GHz ▪ 4GB RAM ▪ fan-less ▪ Remote Video Link, remotation (TX) of DVI-D video signals and USB 2.0 up to 100 m ▪ 24V DC isolated power supply ▪ COMBIVIS connect runtime ▪ 12 months warranty
---------------------	--

	-	RVL	
Remote Assistance	•	•	KEB COMBIVIS connect runtime
Processor	•	•	Intel® Celeron® 3955U ▪ 2,00 GHz, 2MB smart cache ▪ 2 cores, 2 threads ▪ Soldered on board
RAM memory	•	•	4 GB ▪ 1 module SODIMM DDR4-2133
External Monitor output	•		DVI-D (Single Link) video interface for external monitor ▪ Max resolution 1920x1080 FullHD
		•	Remote Video Link integrated ▪ remotation up to 100m of DVI-D video signals and USB 2.0 ▪ without cables > note 1

### 6.2.3 Options

SSD mSATA	mSATA SSD SATA MLC on onboard connect or
CFAST	CFAST SATA
Communication ports	1 x RS232/422/485 (DB15M) isolated ▪ 1 x USB 2.0 > note 2

Note 1	C6 P33 BM RVL has to be used with a MHR100 or MKR100 monitor.
Note 2	Communication boards cannot be installed together.

**6.2.4 Technical specifications**

Case	Wall book mounting
Power supply	24V DC Input voltage: 18÷32V DC
Motherboard	Type "All-In-One" KEB 1351
Watchdog	Time programmable
Intel platform	Processor Intel® Celeron™ dual core 15W ▪ Intel® Core™ 6th generation 15W (25W) Chipset Intel® Skylake U PCH (Platform Controller Hub) ▪ Integrated into processor chip
O.S. certified by KEB	Microsoft Windows Embedded Standard 7P 32bit Other operating systems, such as VxWorks, QNX, etc., have not been certified by KEB but they are reasonably supported by the Intel platform after verification of compatibility
O.S. not supported by Intel platform	Microsoft Windows XP / 2000 / 98 / Microsoft Windows CE 5 / 6
Software Remote assistance	KEB COMBIVIS CONNECT BASIC Win32 runtime license with KEB sticker
Video controller	Intel® HD Graphics 510 integrated into Intel® Celeron™ ▪ 900MHz Intel® HD Graphics 520 integrated into Intel® Core™ ▪ 1,00GHz / 1,05GHz Video RAM (shared)
Video RAM (shared)	Dynamic Video Memory Technology ▪ Memory quantity is automatically selected by operating system ▪ Maximum quantity depends on the operating system version System memory
System memory	DDR4-2133 type ▪ 1 SODIMM modules ▪ min 4GB ▪ max 16GB
Mass storage interfaces	1 x on board connect or for direct insertion of mSATA SSD SATA 3, 6Gb/s
TPM	2x10 (2,54) Pinstrip connect or for optional TPM module
Front signaling (LED)	Power ON ▪ Over temperature / Battery fault ▪ Watchdog / Reset factory default
Front buttons (with open door)	Power ON ▪ System Reset ▪ Watchdog Reset ▪ Factory Default Reset
On Top I/F C6 P33 BM	3 x Ethernet 10/100/1000 Mbps (RJ45), 2 x Intel® I210, 1 x Intel® I219LM ▪ 2 x USB 3.0 (Type A) ▪ 1 x DVI-D Single Link (max resolution: 1920x1200)
On Top I/F C6 P33 BM RVL	3 x Ethernet 10/100/1000 Mbps (RJ45), 2 x Intel® I210, 1 x Intel® I219LM ▪ 2 x USB 3.0 (Type A) ▪ 1 x RJ45 (RVL OUT) remotation (TX) of DVI-D video signals and USB 2.0 up to 100 m
On Front I/F (with front door)	1 x bootable CFAST SATA 3 slot ▪ 1 x system battery slot (CR2032) ▪ 1 x USB 3.0
Environmental specifications	Operating temperature: 0°C÷+50°C, 0°C÷+45°C with 24x7 HDD ▪ Storage temperature: -10° ÷ +60°C ▪ Humidity: 80% (non-condensing)
<i>Table 7: Technical data</i>	



**6.2.5 Power supply technical data**

The power supply board is provided with a FAST FUSE 4A SMD.  
 The fuse can be replaced only in factory.

<b>Power supply</b>	
Type	Isolated DC-DC
Isolation voltage	500 VAC
Input voltage	18÷32V DC
Input protection	Reverse polarity circuitry Overvoltage 4A soldered fuse
Power consumption	45W @ 24V (17W Typ)
Inrush current impulse I <sub>pk</sub> : < 13A t: 2.0 ms	<p>The graph shows a red line representing the inrush current. It starts at zero, rises sharply to a peak value labeled I<sub>pk</sub>, and then decays linearly to zero over a time interval labeled t.</p>
<i>Table 8: Power supply technical data</i>	

6.2.6 System power consumption

In order to calculate the system power consumption it is necessary to add one item for every field of the following tables.

Field	Item	Consumption (W)
C6 P33 BM basic system	Intel® Celeron® dual core 3955U 2,00 GHz ▪ 4GB RAM ▪ fanless ▪ video output DVI-D ▪ Power supply 24V DC isolated	30.0
C6 P33 BM basic system	Intel® Celeron® dual core 3955U 2,00 GHz ▪ 4GB RAM ▪ fanless ▪ video output on Remote Video Link ▪ Power supply 24V DC isolated	34.0
Processor	Intel® Celeron® 3955U ▪ 2,00 GHz, 2MB smart cache ▪ 2 cores, 2 threads ▪ Soldered on-board	+ 0.0
RAM TPM	4 GB ▪ 1 module SODIMM DDR4-2133	-
SSD mSATA	SSD mSATA, SATA 3, 6Gb/s (Solid State Disk), MLC	2.0
CFAST	CFAST SATA	1.0
COMMUNICATION PORTS	1 x RS232/422/485 (DB15M) isolata ▪ 1 x USB 2.0 > note: Communication boards cannot be installed together.	1.0

Table 9: System power consumption

### 6.3 Battery technical data



Figure 52: Battery CR2032 detail

<b>Model</b>	<b>CR2032 MFR renata</b>
Chemical System	Li / MnO <sub>2</sub>
Nominal Voltage	3 V
Rated Capacity	225 mAh
Temperature Range	-30°C - +70°C
Self Discharge at 23°C	< 1% / year

Table 10: Battery technical data

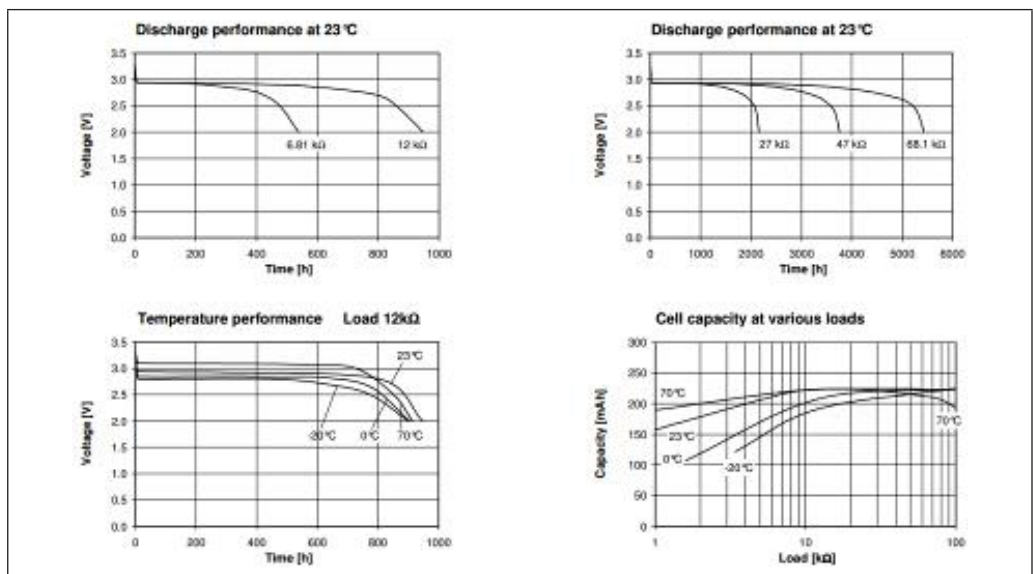

Figure 53: Battery performance

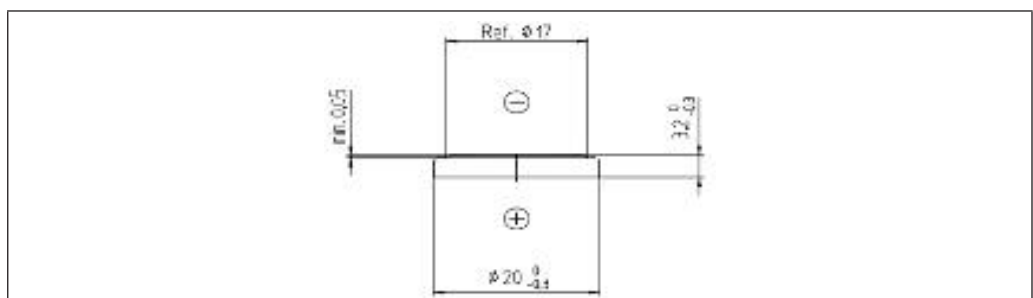

Figure 54: Battery dimensions

## 6.4 Technical support and repairs

KEB offers wide-ranging, complete after-sales technical support. The staff who deal with this handle questions on the entire range of products skilfully, quickly, and efficiently.

You can phone our staff in the service department, and they will give you complete, prompt advice on how to resolve your problems.

telephone: +49 5263 401-0  
fax: +49 5263 401-116  
e-mail: [COMBICONTROL@keb.de](mailto:COMBICONTROL@keb.de)

# 7 Certification

## 7.1 Mark of conformity



**EU DECLARATION OF CONFORMITY**

Document No. / month.year: ce\_ca\_remv-C6H-b\_en / 01.2019

Manufacturer:	KEB Automation KG Südstraße 38 32683 BARNTRUP Germany	
Product type	Control type	yy <b>C6H</b> xx – xxxx
	Control size	yy = 00 for Stand Alone PC or yy = 10 to FF for TouchPanel PC
	Voltage category	x = any letter or number 24 Vdc

The above given product is in accordance with the following directives of the European Union

Number:	<b>EMC : 2014 / 30 / EU</b>
Text:	Directive on the approximation of the laws of the Member States relating to electromagnetic compatibility.
Number:	<b>Hazardous Substances: 2011 / 65 / EEC ( incl. 2015 / 863 / EU )</b>
Text:	Directive on the approximation of the laws of the Member States relating on the restriction of the use of certain hazardous substances in electrical and electronic equipment.

Responsible:	KEB Automation KG Südstraße 38 32683 BARNTRUP
Place, date	Bartrup, 28. December 2018
Issued by:	

  
 \_\_\_\_\_  
 i. A. W. Hovestadt / Conformance Officer

  
 \_\_\_\_\_  
 W. Wiele / Technical Manager

This declaration certifies the conformity with the named directives, but does not contain any assurance of quality.

The safety instructions, described in the instruction manual are to be followed.

---

KEB Automation KG, Südstr. 38, D-32683 Bartrup [www.keb.de](http://www.keb.de) E-Mail: [info@keb.de](mailto:info@keb.de) Tel.: +49 5263 401-0 Fax: -116

# EU DECLARATION OF CONFORMITY



## Annex 1

Document-No. / month.year: ce\_ca\_remv-C6H-b\_en / 01.2019

Product type	Control type	yy <b>C6H</b> xx – xxxx
	Control size	yy = 00 for Stand Alone PC or yy = 10 to FF for TouchPanel PC
	Voltage category	x = any letter or number 24 Vdc

The conformity of the above given product to the European Directive 2014/30/EU ( for electromagnetic compatibility ) is given by complete approval / testing to the following European harmonized standards. For not exceeding the required limits or minimum levels of immunity it is necessary to use observe the given wiring specifications from available instruction manual.

EN - Norm	Text
EN 55032 Version 2015	Electromagnetic compatibility of multimedia equipment – Emission Requirements
EN 61000 – 3 – 2 Version 2014	Electromagnetic compatibility – Part 3-2 Limits – Limits for harmonic current emissions ( equipment input current ≤ 16A per phase )
EN 61000 – 3 – 3 Version 2013	Electromagnetic compatibility – Part 3-3 Limits – Limits of voltage changes, voltage fluctuations and flicker in public low voltage systems, for equipment with rated current ≤ 16A per phase
EN 61000 – 6 – 2 Version 2005	Electromagnetic compatibility (EMC) – Part 6-2: Generic Standard – Immunity standard for industrial environment
EN 55024 Version 2010 + A1 - 2015	Information technology equipment – Immunity characteristics – Limits and methods of measurement

The conformity of the above given product to the European Directive 2011/65/EU with changes of 2015/863/EU ( for restrictions of the use for certain hazardous substances in electrical and electronic equipment ) is given by qualification of components and manufacturing process within the ISO 9001 QM system. The necessary information and declarations are documented and memorized.

The above given product was developed, manufactured and tested within an internal quality management system. This ISO 9001 QM system was approved by:

Notified body:	TÜV - CERT
Adress:	Zertifizierungsstelle des RWTÜV Steubenstrasse 53 D - 45138 Essen
No. of approval	041 004 500
Dated:	20.10.1994
Valid until:	December 2021

## 7.2 UL Marking

# NRAQ.E479848 - Programmable Controllers

## Programmable Controllers

[See General Information for Programmable Controllers](#)

**KEB AUTOMATION KG**  
 SUEDESTRASSE 3B  
 32683 BARNTRUP, GERMANY

E479848

### Investigated to ANSI/UL 508

**Front-Panel Mounting Display, for use on a flat surface of a type 1 and 4X INDOOR enclosure, Model(s) aaC6AF1-44xx** Where "a" may be any character for different sizes of panel display. Where ?xx? can be 02 or 05 representing SW Configuration.

aaC6AF1-45xx Where "a" may be any character for different sizes of panel display. Where ?xx? can be 02 or 05 representing SW Configuration.

**Open type, Programmable controllers** Model(s) 00C6CB1-0100, 00C6CB1-0200, 00C6CB1-0300, 00C6CB1-0400, 00C6CB1-0500, 00C6CB1-0600, 00C6CB1-0700, 00C6CB1-0800, 00C6CB1-0900, 00C6CB1-1000, 00C6CB1-1100, 00C6CB1-1200, 00C6CB1-1300, 00C6CB1-1400, 00C6CB1-1600, 00C6CB1-1700, 00C6CB1-1800, 00C6CB1-1900, 00C6CB1-2000, 00C6CB1-2100, 00C6CC1-0100, 00C6CC1-0200, 00C6CC1-0300, 00C6CC1-0400, 00C6CC1-0500, 00C6CC1-0700, 00C6CC1-0800, 00C6CC1-0900, 00C6CC1-1000, 00C6CC1-1100, 00C6CC1-1200, 00C6CC1-1300, 00C6CC1-1400, 00C6CC1-1500, 00C6CC1-1600, 00C6CC1-1700, 00C6CC1-1800, 00C6CC1-1900, 00C6CE1-0100, 00C6CE1-0200, 00C6CF1-0200, 00C6CH1-0100, 00C6CJ1-0100, 00C6HA1-xxxx, 00C6HB1-xxxx

**Programmable Controllers** Model(s) 00C6CA1-0100 where xy may be 00,02,03,04,06,07,08,09 or 10.

00C6CF1-0100 where xy may be 00,02,03,04,06,07,08,09 or 10.

**Programmable controllers** Model(s) aaC6HA1-xxxx Where "a" may be any character for different sizes of panel display.

aaC6HB1-xxxx Where "a" may be any character for different sizes of panel display.

### Investigated to UL 61010-1 and UL 61010-2-201

**Programmable Automation Controller, PAC** Model(s) C6 Smart, xxC6Gxx-xxxx

### Investigated to UL 61010-1, 3rd Edition and UL 61010-2-201, 1st Edition

**Front-Panel Mounting or Open type Industrial PC** Model(s) 00C6HM1-xxxx Where "xxxx" is a 4 digit / letter combination for different software configurations.

00C6HN1-xxxx Where "xxxx" is a 4 digit / letter combination for different software configurations.

aaC6HM1-xxxx Where "a" may be any character for different sizes of panel display. Where "xxxx" is a 4 digit / letter combination for different software configurations.

aaC6HN1-xxxx Where "a" may be any character for different sizes of panel display. Where "xxxx" is a 4 digit / letter combination for different software configurations.

**Industrial PC** Model(s) 00C6HL1-xxxx Where "xxxx" is a 4 digit / letter combination for different software configurations.

**Industrial PC** Model(s) 00C6HP1-xxxx Where "xxxx" is a 4 digit / letter combination for different software configurations.

00C6HQ1-xxxx Where "xxxx" is a 4 digit / letter combination for different software configurations.

**Programmable controllers** Model(s) aaC6JF1-110x Where "a" may be any character for different sizes of panel display. Where ?x? is any digit representing Customer ID.

aaC6JF1-111x Where "a" may be any character for different sizes of panel display. Where ?x? is any digit representing Customer ID.

aaC6JF1-112x Where "a" may be any character for different sizes of panel display. Where ?x? is any digit representing Customer ID.

### Investigated to UL 61010-1, 3rd Edition and UL 61010-2-201, 2nd Edition

**Programmable Controllers, "Multi Fieldbus Interface C6 Remote I/Os"** Model(s) 00C6CH1-0200, 00C6CH1-0300, 00C6CH1-0400, 00C6CH1-0500

### Investigated to

**Industrial PC** Model(s) 00C6HC1-xxxx

[Last Updated](#) on 2020-03-11





**Austria** | KEB Automation GmbH

Ritzstraße 8 4614 Marchtrenk Austria  
Tel: +43 7243 53586-0 Fax: +43 7243 53586-21  
E-Mail: info@keb.at Internet: www.keb.at

**Benelux** | KEB Automation KG

Dreef 4 - box 4 1703 Dilbeek Belgium  
Tel: +32 2 447 8580  
E-Mail: info.benelux@keb.de Internet: www.keb.de

**Brazil** | KEB South America - Regional Manager

Rua Dr. Omar Pacheco Souza Riberio, 70  
CEP 13569-430 Portal do Sol, São Carlos Brazil  
Tel: +55 16 31161294 E-Mail: roberto.arias@keb.de

**Czech Republic** | KEB Automation GmbH

Videnska 188/119d 61900 Brno Czech Republic  
Tel: +420 544 212 008  
E-Mail: info@keb.cz Internet: www.keb.cz

**France** | Société Française KEB SASU

Z.I. de la Croix St. Nicolas 14, rue Gustave Eiffel  
94510 La Queue en Brie France  
Tel: +33 149620101 Fax: +33 145767495  
E-Mail: info@keb.fr Internet: www.keb.fr

**Germany | Geared Motors**

KEB Antriebstechnik GmbH  
Wildbacher Straße 5 08289 Schneeberg Germany  
Telefon +49 3772 67-0 Telefax +49 3772 67-281  
Internet: www.keb-drive.de E-Mail: info@keb-drive.de

**Italy** | KEB Italia S.r.l. Unipersonale

Via Newton, 2 20019 Settimo Milanese (Milano) Italia  
Tel: +39 02 3353531 Fax: +39 02 33500790  
E-Mail: info@keb.it Internet: www.keb.it

**Japan** | KEB Japan Ltd.

15 - 16, 2 - Chome, Takanawa Minato-ku Tokyo 108 - 0074 Japan  
Tel: +81 33 445-8515 Fax: +81 33 445-8215  
E-Mail: info@keb.jp Internet: www.keb.jp

**P. R. China** | KEB Power Transmission Technology (Shanghai) Co. Ltd.

No. 435 QianPu Road Chedun Town Songjiang District  
201611 Shanghai P.R. China  
Tel: +86 21 37746688 Fax: +86 21 37746600  
E-Mail: info@keb.cn Internet: www.keb.cn

**Poland** | KEB Automation KG

Tel: +48 60407727  
E-Mail: roman.trinczek@keb.de Internet: www.keb.de

**Republic of Korea** | KEB Automation KG

Deoksan-Besttel 1132 ho Sangnam-ro 37  
Seongsan-gu Changwon-si Gyeongsangnam-do Republic of Korea  
Tel: +82 55 601 5505 Fax: +82 55 601 5506  
E-Mail: jaeok.kim@keb.de Internet: www.keb.de

**Russian Federation** | KEB RUS Ltd.

Lesnaya str, house 30 Dzerzhinsky MO  
140091 Moscow region Russian Federation  
Tel: +7 495 6320217 Fax: +7 495 6320217  
E-Mail: info@keb.ru Internet: www.keb.ru

**Spain** | KEB Automation KG

c / Mitjer, Nave 8 - Pol. Ind. LA MASIA  
08798 Sant Cugat Sesgarrigues (Barcelona) Spain  
Tel: +34 93 8970268 Fax: +34 93 8992035 E-Mail: vb.espana@keb.de

**Switzerland** | KEB Automation AG

Witzbergstrasse 24 8330 Pfaeffikon/ZH Switzerland  
Tel: +41 43 2886060 Fax: +41 43 2886088  
E-Mail: info@keb.ch Internet: www.keb.ch

**United Kingdom** | KEB (UK) Ltd.

5 Morris Close Park Farm Industrial Estate  
Wellingborough, Northants, NN8 6 XF United Kingdom  
Tel: +44 1933 402220 Fax: +44 1933 400724  
E-Mail: info@keb.co.uk Internet: www.keb.co.uk

**United States** | KEB America, Inc

5100 Valley Industrial Blvd. South  
Shakopee, MN 55379 United States  
Tel: +1 952 2241400 Fax: +1 952 2241499  
E-Mail: info@kebameric.com Internet: www.kebameric.com

**MORE KEB PARTNERS WORLDWIDE:**

... [www.keb.co.uk/contact/contact-worldwide](http://www.keb.co.uk/contact/contact-worldwide)



**Automation with Drive**

**[www.keb.de](http://www.keb.de)**

KEB Automation KG Suedstrasse 38 32683 Barntrup Tel. +49 5263 401-0 E-Mail: [info@keb.de](mailto:info@keb.de)